

**The Tennessee Walking Horse
The Ride Of Your Life!**

Rule Book

2010 *Revision*
01/01/2010
and beyond

Versatility



© **TWH**  **BEA**[®]
TENNESSEE WALKING HORSE BREEDERS' & EXHIBITORS' ASSOCIATIONSM

For more information, contact: TWHBEA Versatility Program
P.O. Box 286 • Lewisburg, TN 37091-0286 • (931) 359-1574
www.twhbea.com

Contents

Introduction	1
Sections	1
Eligibility.....	1
Awards.....	2
General Requirements and Approved Equipment.....	4
Gait Descriptions.....	5
Class Descriptions:	
Basic Reining	6
Competitive Riding.....	10
Dressage.....	10
Endurance Riding.....	27
English Pleasure	27
Equitation	27
Extreme/Sport	28
Hunter Hack	29
Judged Pleasure Ride.....	29
Model/Halter	29
Pleasure Driving.....	29
Promotion.....	30
Showmanship At Halter.....	30
Timed Speed Events.....	32
Trail Obstacle.....	34
TWH Over Fences	36
Two-Gaited TWH Pleasure.....	37
Untimed Game Events.....	37
Versatility Driving.....	38
Western Pleasure	40
Western Riding	40
Enrollment Application	49

Illustrations

Reining Pattern #1	7
Reining Pattern #2	7
Reining Pattern #3	7
Reining Pattern #4	8
Reining Pattern #5	8
Reining Pattern #6	8
Dressage Intro Level Test A	13
Dressage Intro Level Test B	14
Dressage Training Level Test 1	15
Dressage Training Level Test 2	17
Dressage Training Level Test 3	19
Dressage First Level Test 1.....	21
Dressage First Level Test 3.....	23
Dressage First Level Test 3.....	25
Saddle Seat Equitation Pattern 1	28
Saddle Seat Equitation Pattern 2	28
Stock Seat Equitation Pattern 1	28
Stock Seat Equitation Pattern 2	28
Showmanship Quarter System	30
Showmanship Pattern 1	31
Showmanship Pattern 2	31
Showmanship Pattern 3	31
Barrel Racing Pattern	32
Keyhole Race	33
Pole Bending	33
Stake Race.....	34
Trail Obstacle Course	34
Trail Obstacle Descriptions	35
TWH Over Fences Pattern #1.....	37
TWH Over Fences Pattern #2.....	37
TWH Over Fences Pattern #3.....	37
Western Riding Pattern 1	42
Western Riding Pattern 2	42
Western Riding Pattern 3	43
Western Riding Pattern 4	43

Score Sheets

Basic Reining.....	44
Hunter Hack.....	45
Trail Obstacle	46
TWH Over Fences.....	47
Western Riding	48

TWHBEA Versatility Rule Book – 2010 Revision
Reflects 2010 Superior/Supreme Revisions

INTRODUCTION

The Versatility Program is just one of the many services of the Tennessee Walking Horse Breeders' and Exhibitors' Association! For a minimal one-time fee of \$25.00, a TWHBEA member and their horse can participate in this prestigious, nationwide program.

The Versatility Program is a showcase for the flat-shod Tennessee Walking Horse. With as many as 20 different events from which to choose, you and your horse have a variety of events in which to participate. You may choose to enter one event, or compete in them all!

Some of the divisions are more challenging than others, so perhaps you would like to start with one of the simpler divisions, such as English pleasure, western pleasure, or model. Because the Versatility Program is a self-achievement program which you custom design for you and your horse, you set the goals you'd like to accomplish, and the excitement begins! Prizes, fame, glory, honor, and a sense of accomplishment are in store for you as a participant of the TWHBEA Versatility Program.

To enroll in the Versatility Program, please complete the enrollment application located on the final page of this handbook. (For additional horses, please copy the form or simply write the information on another piece of paper. Upon receipt of your application a point book will be issued in your name. Point books may be submitted to the office at any time during the year to have points documented, but they **must be IN THE TWHBEA OFFICE (not postmarked) by November 1st of each year to count toward that year's high point awards!** (Premium lists from shows or events were you competed must accompany your point book.)

SECTIONS

The program is divided into three sections, one for youth competitors 17 and under, one for adult competitors 18 and over, and one for elite competitors 60 and over. Youth exhibitors may compete on mares or geldings only, while adults and elites may use horses of any sex. All horses must be TWHBEA registered and must be two years old or over.

Youth, adult and elite sections have been designed with the one rider/one horse concept. Points in all sections are awarded to a horse/rider *combination*.

Points earned by a horse in a class designated for youth exhibitors may not be transferred to the adult or elite sections.

ELIGIBILITY

1. In all divisions of the Versatility Program, written nomination must be made to the TWHBEA, listing the recorded name of the horse and the owner of registry record, and the rider.

2. If a youth, adult or elite changes horses any time during the show season, a new point record begins for the horse and rider *team*. Riders may team with as many horses as they'd like during the show season, however each horse and rider team will be issued its own point book.

3. Leased horses are eligible. For horse show purposes, the term "owner" means the person shown as the owner by the records of the TWHBEA or a person who has a bona fide lease on said horse. A bona fide lease is a lease for which TWHBEA has a completed official TWHBEA lease registration form on file.

4. TWHBEA registration shall be required for all horses for eligibility.

5. **TWHBEA membership is required for both owners and exhibitors of horses participating in the youth and adult divisions of the Versatility Program.**

6. All classes are open classes unless specified as an amateur class.

7. All horse shows and events, including schooling shows, are eligible for points through the TWHBEA Versatility Program as long as a licensed judge is used. The only exception is dressage schooling shows where an L candidate is acceptable. The judge's name and licensing organization must be listed in your point book.

8. Youths 17 and under are eligible to show *mares* or *geldings* only, two years of age and over. Horses must be flat shod. ***Pads are prohibited.***

9. Adults 18 and over and elites 60 and over are eligible to show stallions, mares or geldings two years of age or over. Horses must be flat shod. ***Pads are prohibited.***

10. Points are tabulated from the date of nomination on file at the TWHBEA Office.

11. *Misrepresentation of facts* in your point book will result in the *nullification* of the *entire year's points*. If a protest is filed and upheld requiring a versatility entry to forfeit their ribbons and placings, that entrant will also be stripped of ***all*** points earned that year.

12. It is the responsibility of each competitor to make sure all rules as stated in the TWHBEA Versatility Rule Book are followed. The TWHBEA Versatility Rule Book supersedes all other rulebooks for competitors who wish to have points from a particular show or event counted for the TWHBEA Versatility Program. All points must be recorded in an official TWHBEA Versatility Program Point Book for each horse/rider combination. The name and address of the show secretary must be clearly written in the point book for each show and a premium list for each show must accompany the point book when it is turned in. For Dressage, a copy of each score sheet and test must be submitted with the point book. For points in competitive rides, endurance rides, and judged trail rides, a copy of the ride announcement should accompany the point book. For points in promotion, written proof of the event should be submitted with the point book. This can include an event program, media announcement, or letter of participation signed by an appropriate official. For points in Extreme Sport, an event program and copy of the event results must accompany the point book. TWHBEA encourages all HIO's and shows with Walking Horse Versatility classes to recognize the TWHBEA Versatility Rule Book as the Breed Standard. TWHBEA encourages participation in 4-H and open all breed shows.

13. Country Pleasure, Trail Pleasure, Lite Shod, and Plantation Pleasure Classes will count as points for English Pleasure, Western Pleasure, or Two-Gaited TWH Pleasure depending on the class description at the show.

14. Hunter over fences, jumping and crossbar classes will count for points under the TWH Over Fences Division. (**Note:** A TWH Over Fences class is to be judged as a hunter over fences class as per the TWHBEA Versatility Rule Book.)

15. Saddle Seat Equitation, Walking Seat Equitation, Hunt Seat Equitation, Stock Seat Equitation, Western Horsemanship, Good Seat & Hands, and Bareback Equitation will all count as points under the Equitation Division but the classes must be three gaited. Two gaited equitation classes do not count towards points in any division.

AWARDS

TWHBEA National Youth Awards

"Honor Roll"

(Six or more points)

Awarded to the horse and rider who have earned six points in any one division within the year.

"Honor of Merit"

(12 or more points)

Awarded to the horse and rider who have earned 12 points in any one division within the year.

"Register of Merit"

Awarded to the horse and rider who have earned three honor rolls within the year.

Annual "High Point Champion"

Awarded to the horse and rider who have accumulated the most points during the year in each of the Versatility Program's divisions.

"Champion"

(35 or more points)

Awarded when a horse and rider have earned a total of 35 points won in four or more events.

"Superior Versatility Champion"

(55 or more points)

Awarded to the horse and rider that earns 55 or more points in any nine divisions with no less than five points in any single division of the nine. It is mandatory that a minimum of five points be earned in English or western pleasure, but not a combination of the two divisions, and a minimum of five points be earned in Model/Halter or Showmanship, but not a combination of the two divisions. It is also mandatory that 15 or more points be earned in versatility performance divisions, with a minimum of five points in any three of the following divisions: Trail Obstacle, Pleasure Driving, TWH Over Fences, Basic Reining, Western Riding, Timed Speed Events, Untimed Game Events, Versatility Driving, Dressage, Extreme Sport, Competitive Riding, Judged Pleasure Rides, and Endurance Riding.

TWHBEA National Adult Awards

“Honor Roll”

(eight or more points)

Awarded to the horse and rider who have earned eight points in any one division within the year.

“Honor of Merit”

(20 or more points)

Awarded to the horse and rider who have earned twenty points in any one division within the year.

“Register of Merit”

Awarded to the horse and rider who have earned three honor rolls within the year.

Annual “High Point Champion”

Awarded to the horse and rider who have accumulated the most points during the year in each of the Versatility Program’s divisions.

“Champion”

(50 or more points)

The horse and rider must accumulate 50 points.

The points must be accumulated while showing at a minimum of five different horse shows under 5 different judges.

Ten points must be earned in Model/Halter and/or Showmanship.

Ten points must be earned in English and/or western pleasure.

25 points must be earned in a minimum of four performance versatility divisions. (Model and promotion classes are not performance classes.)

“Supreme Versatility Champion”

(100 or more points)

Awarded to the horse and rider than earns 100 or more points in any ten divisions with no less than five points in any single division of the 10. It is mandatory that the horse have achieved champion status. It is mandatory that a minimum of five points be earned in English or western pleasure, but not a combination of the two divisions, and a minimum of five points be earned in Model/Halter or Showmanship, but not a combination of the two divisions. It is also mandatory that 20 or more points be earned in versatility performance divisions with a minimum of five points in any four of the following divisions: Trail Obstacle, Pleasure Driving, TWH Over Fences, Basic Reining, Western Riding, Timed Speed Events, Untimed Game Events, Versatility Driving, Dressage, Extreme Sport, Competitive Riding, Judged Pleasure Rides, and Endurance Riding.

TWHBEA National Elite Awards

“Honor Roll”

(Six or more points)

Awarded to the horse and rider who have earned six points in any one division within the year.

“Honor of Merit”

(12 or more points)

Awarded to the horse and rider who have earned 12 points in any one division within the year.

“Register of Merit”

Awarded to the horse and rider who have earned three honor rolls within the year.

Annual “High Point Champion”

Awarded to the horse and rider who have accumulated the most points during the year in each of the Versatility Program’s divisions.

“Champion”

(35 or more points)

Awarded when a horse and rider have earned a total of 35 points won in four or more events.

“Elite Supreme Versatility Champion”
(55 or more points)

Awarded to the horse and rider that earns 55 or more points in any nine divisions with no less than five points in any single division of the nine. It is mandatory that a minimum of five points be earned in English or western pleasure, but not a combination of the two divisions, and a minimum of five points be earned in Model/Halter or Showmanship, but not a combination of the two divisions. It is also mandatory that 15 or more points be earned in versatility performance divisions, with a minimum of five points in any three of the following divisions: Trail Obstacle, Pleasure Driving, TWH Over Fences, Basic Reining, Western Riding, Timed Speed Events, Untimed Game Events, Versatility Driving, Dressage, Extreme Sport, Competitive Riding, Judged Pleasure Rides, and Endurance Riding.

How Points Are Awarded

In youth adult and elite sections, points will be awarded on the basis of *placement* and the *number of entries* in a given class except where otherwise noted in the class descriptions.

One point is received for each three entries a participant places over, with a maximum of 5 points in any single class for 1st place, 4 points for 2nd place, 3 points for 3rd place, 2 points for 4th place, and 1 point for 5th place. A maximum of ½ point will be awarded to entries tying 6th through 10th place, as long as that entry places over three horses. In classes where there are three or fewer entries, ½ point will be awarded to be counted in the division the class qualifies for.

Points must be won under a licensed judge. The judge’s name and licensing organization must be listed in your point book. Points in youth classes are not transferrable to adult point books. Points won in a youth class may not be counted as adult points.

GENERAL REQUIREMENTS AND APPROVED HORSE EQUIPMENT

1. Classes may be split according to age and/or sex per each show’s discretion for both horse and rider.
2. Barefooted horses may be shown, however, judges must disqualify lame or tender-footed horses.
3. There may be time out to replace a thrown shoe (per affiliating HIO Rule Book).
4. There shall be no curb chain or cavesson adjustment upon the reverse.
5. Braided ribbons shall be worn in saddleseat, model/halter, and showmanship classes, but are prohibited in western classes or whenever western equipment is used.
6. Rhinestone or sequined brow bands and cavesson fronts are allowed.
7. Curb chains or straps must lie flat against the jaw and be at least ½ inch wide. **Cross chain cavessons are prohibited.**
8. Martingales and tie downs are prohibited. (Exception: Timed Speed Events, TWH Over Fences, and Hunter Hack.)
- 8a. Mechanical hackamores are prohibited in all classes except speed events. The judge may disqualify a horse that is using shanks that are felt to be too severe.
9. Action devices, communication transmitting devices, tail braces and **whips** of any kind are prohibited. (**Exception:** whips, not to exceed four feet, are allowed in English Pleasure, English Two-Gaited TWH Pleasure, Model, TWH Over Fences, Hunter Hack, or when riding aside.)
10. Unless otherwise specified in class descriptions, snaffle bits are allowed on any horse. In western or stock seat classes horses five years old and under may be ridden with two hands on the reins with a snaffle bit. In western or stock seat classes, horses over five years old must be ridden with only one hand on the reins regardless of bit.
11. Severe bits **must** be penalized in the final judging. Shanks over nine and one half inches must be eliminated. Gag bits without shanks are not allowed. Shanks are measured from the top of the metal to the very bottom of the metal; the rings are included in the measurement.
12. In western classes, silver mounted equipment shall not count over good working equipment.
13. Bosals are allowed on western horses. Horses five years old and under may be ridden with two hands on reins with a bosal. Horses over five years old must be ridden with one hand on the reins.
14. Approved “leg protection” devices such as splint boots, skid boots, polo wraps, or non-weighted bell boots are accepted as proper leg protection in *TWH over fences, hunter hack, basic reining, western riding, trail obstacle, obstacle driving/gamblers choice, dressage, and timed speed events.*
15. Equipment approved for either English or western classes is approved for trail classes, but not a combination thereof.
16. Any horse entered in the Versatility Program that is turned down by a licensed DQP for sensitivity shall have **all** its Versatility Points nullified from January 1st of that calendar year through the duration of the show where the ticket was received.
17. **No action devices** shall be used on a flat shod pleasure horse on the show grounds. *Penalty:* An automatic two-week suspension.

18. No lubrication below the knee is allowed.

19. Entries shall be plain shod. Shoes must qualify to show in country pleasure, trail pleasure, lite shod, or plantation classes per affiliating HIO and/or show rules. No additional weight shall be allowed on or in the hoof, other than the shoe and nails. Borium is permitted insofar as the shoe continues to meet the measurement requirements set forth by the affiliating HIO and/or show. Bands are not to be used on horses enrolled in the TWHBEA Versatility Program, regardless of the affiliating HIO rules.

19a. Slide plates that extend beyond the bulb of the heel are allowed on the rear hooves in basic reining.

19b. Removable studs or caulks are allowed in timed jumping classes.

20. Australian stock saddles are not approved as either English or western tack.

21. Side saddles are approved equipment in flat shod pleasure and versatility classes.

22. In timed events and/or individually worked classes such as barrel racing, pole bending, western riding, trail obstacle, basic reining, TWH over fences, etc., a particular horse counts as one entry. The only time a horse can be entered in a timed event or trail class with two different riders is if the class is an open class and one of the riders is an adult or elite and the other is a youth exhibitor, and this is allowed only if there is no other class for the adult/elite or youth exhibitor.

GAIT DESCRIPTIONS

Flat walk: The flat walk is the basic, loose four cornered lick, a 1-2-3-4 beat with each of the horse's feet hitting the ground separately at regular intervals (the left front, then the right rear, the right front, then the left rear). The horse will glide over the track of the front foot with his hind foot; (right rear over right front – left rear over left front). The action of the back foot slipping over the front track is known as overstride. Overstride is unique to the Tennessee Walking Horse breed. A Tennessee Walking Horse will nod his head in rhythm with the cadence of its feet. This unique head motion along with overstride are two things the judge should take into consideration when judging a Tennessee Walking Horse.

Running walk: This smooth, gliding gait is what made the Tennessee Walking Horse famous. Executed with loose ease of movement pulling with the fore feet and pushing and driving with the rear, this gait is natural to the breed. It is basically the same gait as the flat walk with an increase in speed. There should be a noticeable difference in the rate of speed between the flat walk and the running walk *but a good running walk should never allow proper form to be sacrificed for excessive speed*. A true Tennessee Walking Horse will continue to nod while performing the running walk. Judging should not be influenced by speed, but rather by the true form exhibited.

Canter: The canter is basically a collected gallop. It should be smooth and rolling with **no pumping** of the reins; a collected movement that is enjoyable to ride. This smooth gait is often referred to as the “rocking chair” canter.

CLASS DESCRIPTIONS

Basic Reining

Course should be posted prior to class. Western attire and tack required. Approved equipment includes slide plates, skid boots, splint boots and polo wraps. The use of any type hackamore is not permitted with the exception of a bosal. Scoring will be on the basis of 0 to 100, with 70 denoting an average performance. Each horse will be judged on the neatness, dispatch ease, calmness, and speed with which it performs the pattern. If a horse goes off course or breaks pattern, it will be disqualified.

Junior horses five years old and under may be ridden in a snaffle bit or bosal using two hands on the reins.

Basic Reining Penalties

(a) The following will result in a score of 0:

- (1) Use of more than index or first finger between reins;
- (2) Use of two hands (exception on a junior horse being ridden in a snaffle bit or bosal) or changing hands;
- (4) Failure to complete pattern as written;
- (5) Performing the maneuvers other than in specified order;
- (6) The inclusion of maneuvers not specified, including, but not limited to
 - (A) Backing more than 2 strides
 - (B) Turning more than 90 degrees
- (7) Equipment failure that delays completion of pattern; including dropping a rein that contacts the ground while horse is in motion.
- (8) Balking or refusal of command where performance is delayed;
- (9) Running away or failing to guide where it becomes impossible to discern whether the entry is on pattern;
- (10) Running walk in excess of one-half circle or one-half the length of the arena;
- (11) Overspins of more than 1/4 turn;
- (12) Fall to the ground by horse or rider

(b) The following will result in a reduction of five points:

- (1) Spurring in front of cinch;
- (2) Use of either hand to instill fear or praise;
- (3) Holding saddle with either hand;
- (4) Blatant disobediences including kicking, biting, bucking, rearing and striking.

(c) The following will result in a reduction of two points:

- (1) Break of gait;
- (2) Freeze up in spins or rollbacks;
- (3) On walk-in patterns, failure to stop or walk before executing a canter departure.
- (4) On run-in patterns, failure to be in a canter prior to the first marker.
- (5) If a horse does not completely pass the specified marker before initiating a stop position.

(d) Starting or performing circles or eights out of lead will be judged as follows:

Each time a horse is out of lead, a judge is required to deduct one point. The penalty for being out of lead is accumulative and the judge will deduct one penalty point for each quarter of the circumference of a circle or any part thereof that a horse is out of lead. A judge is required to penalize a horse one-half point for a delayed change of lead by one stride where the lead change is required by the pattern description.

(e) Deduct 1/2 point for starting circle at a running walk or exiting rollbacks at a running walk up to two strides. Running walk beyond two strides, but less than 1/2 circle or 1/2 the length of the arena, deduct two points.

(f) Deduct 1/2 point for over or under spinning up to one-eighth (1/8) of a turn; deduct one (1) point for over or under spinning from one-eighth to one-fourth (1/8 to 1/4) turn.

(g) A 1/2 point penalty deduction will be given for failure to remain a minimum of 20 feet (6 meters) from the wall or fence when approaching a stop and/or rollback.

(h) In patterns requiring a run-around, failure to be on the correct lead when rounding the end of the arena will be penalized as follows: for 1/2 the turn or less, one (1) point; for more than 1/2 turn, two (2) points.

(i) Faults against the horse to be scored accordingly, but not to cause disqualification:

- (1) Opening mouth excessively when wearing bit;
- (2) Excessive jawing, opening mouth or head raising on stop;
- (3) Lack of smooth, straight stop on haunches-bouncing or sideways stop;
- (4) Refusing to change leads;
- (5) Anticipating signals;

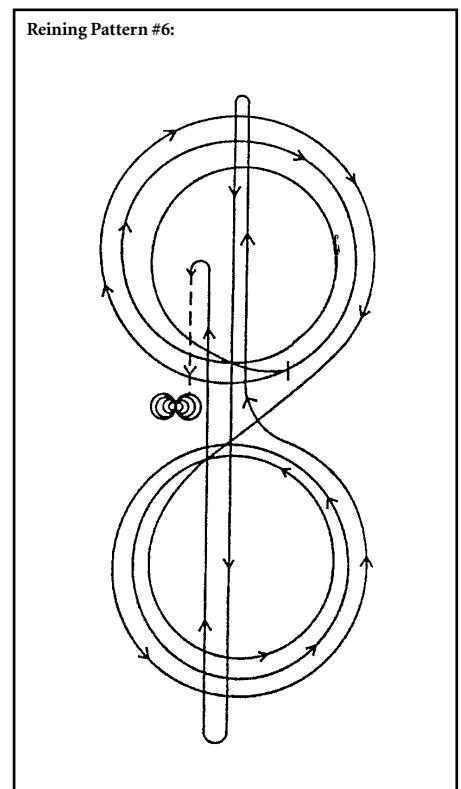
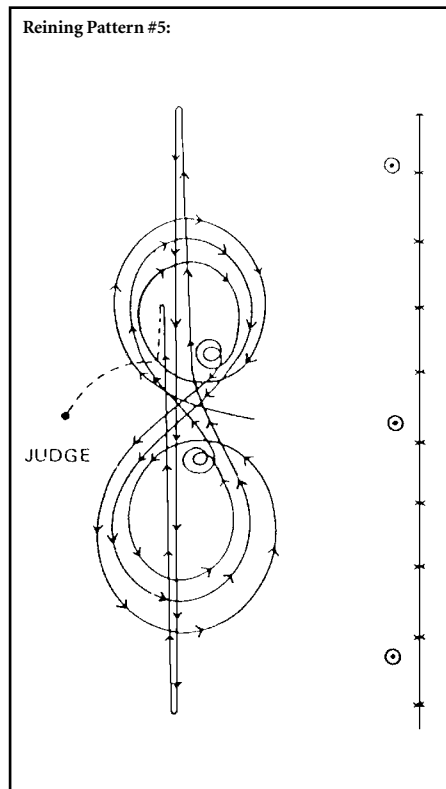
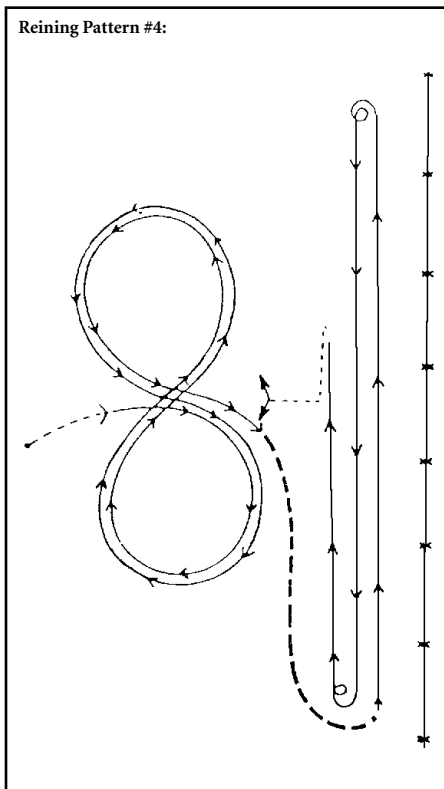

Reining Pattern #2:

The area or plot should be approximately 50 feet by 150 feet in size. The judge will indicate with markers on arena fence or wall the length of the pattern. Markers within the area of the pattern will not be used. Ride pattern as follows:

1. Run with speed, past center marker.
2. Stop and back up to center of pattern.
3. Settle horse for approximately 10 seconds. Start lope. Circles should be made inside the end markers.
4. Ride 2 circles to the right, the first small and slow the second large and fast.
5. Ride 2 circles to the left, the first small and slow the second large and fast.
6. Left roll back over hocks (should be made past far end marker).
7. Right roll back over hocks (should be made past near end marker).
8. Stop (should be made past center marker). Let horse settle, then in appropriate area of stop, do the pivots.
9. Pivot right or left no more than 90 degrees.
10. Pivot opposite direction, no more than 180 degrees.
11. Walk to judge and stop for inspection until dismissed.
12. The bridle may be dropped at the judge's discretion.

Reining Pattern #3:

The area or plot should be approximately 50 feet by 150 feet in size. The judge will indicate with markers on arena fence or wall the length of the pattern. Markers within the area of the pattern will not be used. Ride pattern as follows:

1. Run past center of established pattern area and do a sliding stop.
2. Back immediately to center of pattern, hesitate.
3. Do 2 spins to the right.
4. Do 2 and a quarter spins to the left, hesitate.
5. Beginning on left lead make a small, slow circle, then begin a large fast circle. Do not close this circle, but run straight down the side past center marker and do a right roll back at least 20 feet from fence or wall.
6. Continue back to center of pattern, horse should be on right lead at center, make a small slow circle to the right, then begin a large fast circle. Do not close this circle, but run straight down the side past center and do a left roll back at least 20 feet from wall or fence.
7. Continue back to center of pattern, horse should be on the left lead at center.
8. Make a large fast circle to the left at center of pattern, change leads and make a large fast circle to the right at center of arena - change leads and begin a large, fast circle to the left. Do not close this circle, but run straight down the side past the center maker and do a sliding stop at least 20 feet from fence or wall.

9. Walk to judge and stop for inspection until dismissed.
10. The bridle may be dropped at the judge's discretion.

Reining Pattern #4:

The area or plot should be approximately 50 feet by 150 feet in size. The judge will indicate with markers on arena fence or wall the length of the pattern. Markers within the area of the pattern will not be used. Ride pattern as follows:

1. Begin work to the right.
2. First figure eight slow.
3. Second figure 8, faster (lead change must take place at Point A).
4. Proceed from Point B to Point C at flat walk or running walk.
5. Begin run.
6. Sliding stop.
7. Turn away from the rail do a spin and a half, no hesitation; begin run.
8. Sliding stop.
9. Turn away from the rail do a spin and a half with no hesitation; begin run.
10. Sliding stop.
11. Back over slide marks. Face judge, walk a few steps.
12. Pivot right or left, no more than 90 degrees.
13. Pivot the opposite direction, no more than one hundred eighty 180.
14. Pivot in direction taken as #12, no more than one hundred eighty 180.
15. Walk to judge and stop for inspection until dismissed.
16. The bridle may be dropped at the judge's discretion.

Reining Pattern #5:

The area or plot should be approximately 50 feet by 150 feet in size. The judge will indicate with markers on arena fence or wall the length of pattern, markers within the area of the pattern will not be used. Ride pattern as follows:

1. Starting in the center of the established pattern area, make a large, fast circle to the right.
2. Draw the circle down to a small circle until you reach the center of the established pattern area - stop.
3. Do a double spin to the inside of the small circle in the center of the established pattern area. At end of spins, horse should be facing the left wall, slight hesitation.
4. Begin on left lead and make a large, fast circle.
5. Then a small circle again drawing it down to the center of the established pattern area - stop - no hesitation on these stops.
6. Do a double spin to the inside of the circle slight hesitation- horse to be facing left wall.
7. Begin on right lead and make a fast figure eight over the large circles - and change leads.
8. Run to far end of established pattern area and do a left roll back.
9. Run to the opposite end of the established pattern area and do a right roll back.
10. Run back past center of the established pattern area and do a sliding stop. Hesitate.
11. Back over slide tracks.
12. Finish, walk to judge for inspection and dismissal.
13. The bridle may be dropped at the judge's discretion.

Reining Pattern #6:

The area or plot should be approximately 50 by 150 feet in size. The judge will indicate with markers on arena fence or wall the length of the pattern. Markers within the area of the pattern will not be used. Ride pattern as follows:

Beginning at the center of the established pattern area facing the left wall or fence:

1. Beginning on the right lead, complete 3 circles to the right: the first circle small and slow; the next 2 circles large and fast. Change leads at the center of the established pattern area.
2. Complete 3 circles to the left: the 1st circle small and slow; the next 2 circles large and fast. Change leads at the center of the established pattern area.
3. Run up the middle to the far end of the established pattern area past the end marker and do a left rollback – no hesitation.
4. Run to the opposite end of the established pattern area past the end marker and do a right rollback – no hesitation.
5. Run past the center marker and do a sliding stop. Back up at least 10 feet. Hesitate.
6. Complete 4 spins to the right.
7. Complete 4 spins to the left. Hesitate to demonstrate the completion of the pattern.
8. Exhibitor may drop bridle to designated judge.

Competitive Riding

In competitive rides points count as follows: the first finishing TWH gets three points; the second finishing TWH gets two points; one point is awarded to any TWH that finishes a ride.

Additional points will be added to a horse's total points as follows: One point for completion of a ride more than 100 miles in length; three points for Best Conditioned of the Ride; and three points for 1st Overall Horse.

Competitive riding uses time, distance and stress, not speed, as judging criteria and therefore should not be confused with endurance riding. Judging is based upon each horse starting the ride with a score of 100 points, evaluating as follows: Soundness 40%, Condition 40%, Manners 15%, Way-of-Going 5%.

While primary judging is on the horse, riders also compete for awards and are judged on the care and handling of their mounts throughout the entire ride. All forward movement of the horse must be made while the rider is mounted. Horses must be at least four years of age.

Daily mileage is between 25 and 40 miles (depending on the difficulty of the terrain) to be covered in 6 ½ to 7 hours riding time. The main objective is to work all the horses over an identical trail in the same length of time, thereby having a basis of fair comparison for determining the horse's soundness, condition, and manners. While this is not a race, judgement in timing and pacing is important; the winner being the one whose horse was ridden at a consistent pace throughout the ride.

Dressage

Points are accepted from any recognized dressage competition under a licensed judge, such as USEF, USDF, Trophaeum Mundi International; or from open or TWH shows at which TWHBEA approved dressage tests are used and a licensed judge presides. Dressage points will count as long as show management has an approved dressage person judging the dressage events with a licensed judge on the show grounds. In the event a show does not offer separate classes for youth and adult competitors, a horse may be shown by only one youth and one adult in any event. For dressage tests that are training level or higher, one point will be awarded for a score 58 or above. An additional point will be awarded for a score 63 and above. For introductory tests, 1/2 point will be awarded for a score 58 or higher and an additional 1/2 point will be given for scores 63 and higher. Exhibitors must turn in a copy of their score sheet along with a copy of the class sheet and the test used when submitting their point book. Exhibitors should check with other organizations for their rules before competing.

At a single event a horse and rider team may only compete in tests in two consecutive levels. There is no limit to the number of tests within those levels however.

The object of Dressage is the harmonious development of the physique and ability of the horse. It makes the horse calm, supple, loose, and flexible but also confident, attentive and keen thus achieving perfect understanding with his rider. These qualities are revealed by:

- The freedom and regularity of the gaits
- The harmony, lightness, and ease of movements
- The lightness of the forehand and the engagement of the hindquarters, originating in a lively impulsion
- The acceptance of the bridle with submissiveness throughout and without any tenseness or resistance.

The Gaits of Dressage include:

- The Halt – At the halt, the horse should be attentive, motionless, and straight with the weight evenly distributed all over four legs being by pairs abreast with each other. The neck should be raised, the poll high and the head slightly in front of the vertical.
- The Working Walk – The working walk is a march gait in which the footfalls of the horse's feet follow one another in "four-time", well marked and maintained in all work at the walk.
- Flat Walk/Running Walk – The flat walk and running walk are marching gaits of "four-time", with each foot following the other in a regular rhythm. The flat walk and running walk, with free, active, and regular steps, should be moved into without hesitation.
- The Canter – The canter is a gait of "three time", where at canter to the right, for instance, the footfalls follow one another as follows: left hind, left diagonal (simultaneously left fore and left hind), right fore, followed by a moment of suspension with all four feet in the air. The canter should be light, cadenced and regular strides, should be moved into without hesitation.

Within the gaits, different degrees of collection and extension are recognized. They are:

- Collected Gait – The horse, remaining on the bit, moves resolutely forward, with his neck raised and arched, and showing clear self-carriage. The head approaches the vertical position, the light contact with the mouth being maintained. The hind legs are engaged with good hock action. The gait should remain marching and vigorous, the feet being placed in regular sequence. Each step covers less ground than at the working gait.

- Working Gait – This is a gait in which a horse not yet trained and ready for collected movements shows himself properly balanced, and remaining on the bit, goes forward with even, elastic steps. Impulsion from the hindquarters is evident.
- Medium Gait – This is a gait between the working gait and the extended gait, but more “round” than the latter. The horse goes forward with the free and moderately extended steps and an obvious impulsion from the hindquarters.
- Extended Gait – The horse covers as much ground as possible. Maintaining the same cadence, he lengthens his steps to the utmost as a result of great impulsion from the hindquarters. The rider allows the horse remaining on the bit without leaning on it to lengthen his frame and to gain ground. The running walk is considered an extended flat walk.
- Free Walk – The free walk is a gait of relaxation in which the horse is allowed complete freedom to lower and stretch out his head and neck.
- The Rein Back – The rein back is an equilateral movement in which the feet are raised and set down by diagonal pairs. The feet should be well raised and the hind feet remain the line.

Tack & Attire

English tack and attire are acceptable, either hunt seat, saddle seat or traditional dressage attire. A whip of no longer than 4 ft. including sash may be carried. Snaffle bits are required. All bits must be smooth and solid. Twisted, wire, and roller bits are prohibited. All parts of the bit coming into the horse’s mouth must be made of entirely the same metal. The following bits are permitted:

- Ordinary snaffle with single-jointed mouth piece
- Ordinary snaffle with double-jointed mouth piece
- Racing (dee-ring) snaffle
- Full-cheek snaffle
- Egg-butt snaffle
- Snaffle with upper or lower cheeks
- Unjointed (mullen-mouth) snaffle
- Dr. Bristol
- Fulmer
- French snaffle
- Snaffle with rotating mouthpiece
- Snaffle with cheeks (hanging or drop cheek; Baucher) this may be a dee-ring or other ordinary snaffle

The bridle must include a regular cavesson, a dropped noseband, a flash noseband, a crescent noseband, or a crossed noseband. A breastplate and/or crupper may be used. Martingales and tie-downs are prohibited, as are blinkers, ear muffs or plugs, nose covers, seat covers, and hoods.

The Arena

The arena should be on as flat and as level a ground as possible. The Standard arena is 60 meters long and 20 meters wide. The small arena is 40 meters long and 20 meters wide. All levels above first level must compete in the standard arena. The enclosure should consist of a low fence about 0.3 meters (1 foot) high, or other suitable denotation. Part of the fence at A should be easily removed for entry to and exit from the arena.

The letters should be placed outside the arena and be clear and easy to read. To assist the judges in noting the exact point on the track, markers may be placed along the fence, level with and in addition to the letter concerned.

Tests for Dressage Competitions

Tests are written using a prescribed configuration within the arena above. Letters are placed so that transitions, turns, circles, etc. may commence at a specific place within the arena. Each level of test increases in difficulty and the amount of training the horse must possess.

A test begins with the entry at A and ends after the final salute. As soon as the horse moves forward, except in freestyle, where the test begins at the first stride after the salute and ends at the final salute. Anything before the beginning or after the end of the test has no effect on the marks. The competitor should leave the arena in the way prescribed by the test.

Objectives and Standards of Levels of Competition:

- Introductory Level – To determine that the horse is willing to learn and quiet and supple in his gaits. The horse should move forward with a steady rhythm, and should begin to accept contact with the bit.
- Training Level – To confirm that the horse’s muscles are supple and loose, and that it moves freely forward in clear and steady rhythm, accepting contact with the bit.
- First Level – To confirm that the horse, in addition to the requirements of Training Level, has developed thrust (pushing power) and achieved a degree of balance and thoroughness.

Execution of the Tests

Calling tests – All tests may be called during the competition. If tests are announced, it is the responsibility of the competitor to arrange for a person to announce the test. Lateness and errors in announcing will not relieve the rider from “error penalties”.

Salute – At the salute, riders must take the reins in one hand. A lady rider shall let one arm drop loosely along her body and then incline her head in a slight bow; a gentleman rider shall remove his hat and let his arm drop loosely along his body or may render a salute as does the lady rider. The military salute is only permissible when riding in uniform.

Unauthorized assistance is forbidden under penalty of elimination. Any intervention by a third party with the object of facilitating the task of the competitor is considered illegal assistance. The judge may discuss a ride with a competitor before the bell or after the final salute.

Scoring

All movements and certain transitions from one to another which have to be marked by the judge are numbered on the judge’s sheets. They are marked 0 to 10, 0 being the lowest mark and 10 being the highest.

The scale of marks following

- 10 – Excellent
- 9 – Very Good
- 8 – Good
- 7 – Fairly Good
- 6 – Satisfactory
- 5 – Sufficient
- 4 – Insufficient
- 3 – Fairly Bad
- 2 – Bad
- 1 – Very Bad
- 0 – Not Executed

Collective marks are awarded (from 0 to 10) after the competitor has finished his performance for:

- Gaits
- Impulsion
- Submission
- The rider’s position and seat; correctness and effect of the aids.

The collective marks as well as certain difficult and/or infrequently repeated movements can be given a coefficient which is fixed by the TWHBEA.

Errors

When a competitor makes an “error of the course” (takes a wrong turn, omits a movement, etc.), he is warned by the judge or ground jury. He is then shown, if necessary, the point at which he must take up the test again and the next movement to be executed then is left to continue by himself.

Every course must be penalized as follows:

- 1st time by two points
- 2nd time by four points
- 3rd time by eight point
- 4th time – the competitor is eliminated although he may continue his performance to the end, the marks being awarded in the ordinary way.

Elimination

Horse and rider shall be eliminated under the following circumstance:

- misrepresentation of entry and inappropriate entry
- use of illegal equipment
- unauthorized assistance
- four errors on the course
- horse’s tongue tied down
- late entry into the arena
- all four feet of the horse leave the arena
- cruelty
- marked lameness or soreness
- resistance of longer than 20 seconds
- any situation where a direct rule violation can be cited

2011 Intro Level Test A

No: _____

Purpose: To introduce the rider and/or horse to the sport of dressage. To show understanding of riding the horse forward with a steady tempo into an elastic contact with independent, steady hands and a correctly balanced seat. To show proper geometry of figures in the arena with correct bend (corners and circles).

Conditions: Arena: standard or small. Average time: 5:00 minutes (std) or 4:00 (sm) (Possibly longer for schooling shows)

Coefficient						
	Test	Directive Ideas	Points	↓	Total	Remarks:
1 A Between X & C	Enter flatwalk, Medium walk	Straightness on centerline and in transition. Clear flatwalk and walk rhythm.				
2 C M	Track right. Flatwalk	Balance and bend in turn. Quality of transition.				
3 A	Circle right 20 meters, flatwalk	Roundness and size of circle, clear flatwalk rhythm and bend.				
4 KXM	Change rein	Clear flatwalk rhythm and Straightness on diagonal. Bend through corners.				
5 C	Circle left 20 meters, flatwalk	Roundness and size of circle, clear flatwalk rhythm and bend.				
6 Between C & H	Medium walk	Willing and balanced transition; clear walk rhythm.				
7 HXF	Free walk	Complete freedom to stretch neck forward and downward; clear walk rhythm. Straightness on the diagonal. Ground cover.				
8 F-A A	Medium walk Down Centerline	Willing and balanced transition; clear walk rhythm, bending in corner and turn. Straightness on centerline.				
9 X	Halt and salute	Straightness in halt, willing and balanced transition and halt.				

Leave arena in free walk. Exit at A.

COLLECTIVE MARKS:

GAITS: Freedom and regularity.		1		
IMPULSION: Desire to move forward with suppleness of the back and steady tempo.		1		
SUBMISSION: Acceptance of steady contact, attention and confidence.		2		
RIDER'S POSITION: Keeping in balance with horse.		1		
RIDER'S EFFECTIVENESS OF AIDS: correct bend and preparation of transitions.		1		
GEOMETRY and ACCURACY: correct size and shape of circles and turns.		1		

Further Remarks:

Subtotal: _____

Errors: (-) _____

Total Points: _____

÷ 160 Pts = % Score: _____

2011 Intro Level Test B

No: _____

Purpose: To introduce the rider and/or horse to the sport of dressage. To show understanding of riding the horse forward with a steady tempo into an elastic contact with independent, steady hands and a correctly balanced seat. To show proper geometry of figures in the arena with correct bend (corners and circles).

Conditions: Arena: standard or small. Average time: 5:00 minutes (std) or 4:00 (sm) (Possibly longer for schooling shows)

	Test	Directive Ideas	Points	↓	Total	Remarks:
1 A X	Enter flatwalk Halt thru medium walk, Salute - Proceed flatwalk	Straightness on centerline, and in transition. Clear flatwalk and walk rhythm.				
2 C	Track left, flatwalk	Balance and bend in turn.				
3 E E	Circle left 20 meters, flatwalk Straight ahead.	Roundness and size of circle, clear flatwalk rhythm and bend.				
4 Between K & A	Medium walk	Willing and balanced transition, walk rhythm.				
5 F - E	Free walk	Complete freedom to stretch neck forward and downward, clear walk rhythm. Straightness on the diagonal. Ground cover.				
6 E - H	Medium walk	Willing and balanced transition, clear walk rhythm.				
7 Between H & C	Flatwalk	Willing and balanced transition, clear flatwalk rhythm.				
8 B	Circle right 20 meters, flatwalk	Roundness and size of circle, clear flatwalk rhythm and bend.				
9 A X	Down centerline Halt thru medium walk, salute	Straightness on centerline and in halt, willing and balanced transition and halt.				

Leave arena in free walk. Exit at A.

COLLECTIVE MARKS:

GAITS: Freedom and regularity.		1		
IMPULSION: Desire to move forward with suppleness of the back and steady tempo.		1		
SUBMISSION: Acceptance of steady contact, attention and confidence.		2		
RIDER'S POSITION: Keeping in balance with horse.		1		
RIDER'S EFFECTIVENESS OF AIDS: Correct bend and preparation of transitions.		1		
GEOMETRY and ACCURACY: Correct size and shape of circles and turns.		1		

Further Remarks:

Subtotal: _____

Errors: (-) _____

Total Points: _____

÷ 160 Pts = % Score: _____

2011 Training Level Test 1

No: _____

Purpose: To confirm that the horse is supple and moves freely forward in a clear and steady rhythm, accepting contact with the bit. Halts may be through the walk.

Conditions: Arena: Standard or Small; Avg. Time: 5:00 (std) or 4:00 (small); Maximum possible points: 240.

Coefficient

	Test	Directive Ideas	Points	↓	Total	Remarks:
1 A X	Enter flatwalk Halt, Salute Proceed Flatwalk	Straightness on centerline and in halt, immobility, quality of flatwalk, willing and balanced transitions				
2 C E	Track left Circle left 20m	Bend and balance in turn; quality of flatwalk; shape and size of circle; bend.				
3 A AFB	Circle left 20m, developing left lead canter second half of circle Working canter	Quality of flatwalk and canter; willing, calm transition; shape and size of circle; bend				
4 B-E	Half circle left 20 meters	Quality of canter, shape and size of half circle; bend				
5 Between E & K	Flatwalk	Willing, balanced transition; quality of canter and flatwalk				
6 A Before A A	Circle left 20 meters flatwalk, allowing the horse to stretch forward and downward Shorten the reins Flatwalk	Forward and downward stretch over the back into a light contact maintaining balance and quality of flatwalk; bend; shape and size of circle; smooth, balanced transitions		2		
7 Between A & F	Medium walk	Willing, balanced transition; quality of flatwalk and medium walk.				
8 FXH H-C	Free walk Medium walk	Reach and ground cover of free walk allowing complete freedom to stretch the neck forward and downward; quality and regularity of medium walk; willing, balanced transitions; straightness on diagonal.		2		
9 C	Flat walk	Willing, balanced transition; quality of flatwalk.				
10 B	Circle right 20 meters	Quality of flatwalk; shape and size of circle; bend.				
11 A AKE	Circle right 20 meters, developing right lead canter second half of circle Working canter	Quality of flatwalk and canter; willing, calm transition; shape and size of circle; bend.				
12 E-B	Half circle right 20 meters	Quality of canter; shape and size of half circle; bend.				

13 Between B & F	Flat walk	Willing, balanced transition; quality of canter and flatwalk.				
14 A X	Down centerline Halt, Salute	Bend and balance in turn; straightness on centerline and in halt; willing, balanced transition; immobility.				

Leave arena at A in walk on a long rein

COLLECTIVE MARKS:

GAITS: Freedom and regularity.		1		
IMPULSION: Desire to move forward, elasticity of the steps, suppleness of the back, engagement of the hindquarters.		2		
SUBMISSION: Attention and confidence, lightness and ease of movements, acceptance of the bridle, lightness of the forehand.		2		
RIDER'S position and seat		1		
RIDER'S correct and effective use of the aids		1		
HARMONY between rider and horse		1		

Further Remarks:

Subtotal: _____

Errors: (-) _____

Total Points: _____

÷ 240 Pts = % Score: _____

2011 Training Level Test 2

No: _____

Purpose: To confirm that the horse is supple and loose and moves freely forward in a clear and steady rhythm, accepting contact with the bit. Halts may be through the walk.

Conditions: Arena: Standard or Small; Avg. Time: 5:30 (std) or 4:30 (small); Maximum possible points: 280.

Coefficient

	Test	Directive Ideas	Points	↓	Total	Remarks:
1 A X	Enter flatwalk Halt, Salute Proceed Flatwalk	Straightness on centerline and in halt; immobility; quality of flatwalk; willing, balanced transitions.				
2 C B	Track right Circle right 20m	Bend and balance in turn; quality of flatwalk; shape and size of circle; bend.				
3 KXM	Change rein at the flatwalk	Quality of flatwalk; straightness on diagonal; bend.				
4 Between C & H	Working canter left lead	Willing, calm transition; quality of flatwalk and canter; bend through corner.				
5 E	Circle left 20m	Quality of canter; shape and size of circle; bend.		2		
6 Between E & K	Flatwalk	Willing, balanced transition; quality of canter and flatwalk.				
7 A Before A A	Circle left 20 meters flatwalk, allowing the horse to stretch forward and downward Shorten the reins Flatwalk	Forward and downward stretch over the back into a light contact maintaining balance and quality of flatwalk, bend; shape and size of circle; smooth, balanced transitions.		2		
8 Between A & F	Medium walk	Willing, balanced transition; quality of flatwalk and medium walk.				
9 FXM M-C	Free walk Medium walk	Reach and ground cover of free walk allowing complete freedom to stretch the neck forward and downward; quality and regularity of medium walk; willing, balanced transitions; straightness on diagonal.		2		
10 C	Flatwalk	Willing, balanced transition; quality of flat walk.				
11 E	Circle left 20m	Quality of flatwalk; shape and size of circle, bend.				→
12 FXH	Change rein Flatwalk	Quality of flatwalk; straightness on diagonal; bending through corners.				
13 Between C & M	Working canter right lead	Willing, calm transition; quality of flatwalk and canter; bend.				
14 B	Circle right 20m	Quality of canter; shape and size of circle; bend.		2		

15 Between B & F	Flatwalk	Willing and balanced transition; quality of canter and flatwalk.				
16 A X	Down centerline Halt, salute	Bend and balance in turn; straightness on centerline and in halt; willing, balanced transition; immobility.				

Leave arena at A in walk on a long rein

COLLECTIVE MARKS:

GAITS: Freedom and regularity.		1		
IMPULSION: Desire to move forward, elasticity of the steps, suppleness of the back, engagement of the hindquarters.		2		
SUBMISSION: Attention and confidence, lightness and ease of movements, acceptance of the bridle, lightness of the forehand.		2		
RIDER'S position and seat.		1		
RIDER'S correct and effective use of the aids		1		
HARMONY between rider and horse		1		

Further Remarks:

Subtotal: _____

Errors: (-) _____

Total Points: _____

÷ 280 Pts = % Score: _____

2011 Training Level Test 3

No: _____

Purpose: To confirm that the horse is supple and moves freely forward in a clear and steady rhythm, accepting contact with the bit. Halts may be through the walk.

Conditions: Arena: Standard or Small; Avg. Time: 5:00 (std) or 4:00 (small); Maximum possible points: 250.

		Coefficient				
	Test	Directive Ideas	Points	↓	Total	Remarks:
1 A X	Enter flatwalk Halt, Salute Proceed Flatwalk	Straightness on centerline and in halt; immobility; quality of flatwalk; willing, balanced transitions.				
2 C HXK	Track left One loop	Bend and balance in turn; quality of flatwalk; shape and size of loop; changes of bend.				
3 Between A & F	Working canter left lead	Willing, calm transition; quality of flatwalk and canter; bend.		2		
4 B	Circle left 20 meters	Quality of canter; shape and size of circle; bend.				
5 HXF X	Change rein Flatwalk	Quality of canter and flatwalk; willing, balanced transition; straightness on diagonal.				
6 A A-K	Medium walk Medium walk	Willing, balanced transition; quality of walk.				
7 KXH H-C	Free walk Medium walk	Reach and ground cover of free walk allowing complete freedom to stretch the neck forward and downward; quality and regularity of medium walk; willing, balanced transitions; straightness on diagonal.		2		
8 C MXF	Flatwalk One loop	Quality of flatwalk; willing, balanced transition; shape and size of loop; changes of bend.				
9 Between A & K	Working canter right lead	Willing, calm transition; quality of flatwalk and canter; bend.		2		
10 E	Circle right 20 meters	Quality of canter; shape and size of circle; bend.				
11 C	Flatwalk	Willing, balanced transition; quality of flatwalk.				
12 B Before B	Circle right 20 meters in flatwalk allowing the horse to stretch forward and downward Shorten the reins	Forward and downward stretch over the back into a light contact maintaining balance and quality of flatwalk; bend; shape and size of circle; smooth, balanced transitions.		2		
13 A X	Down centerline Halt, Salute	Bend and balance in turn; straightness on centerline and in halt; willing, balanced transition, immobility.				

Leave arena at A in walk on a long rein

COLLECTIVE MARKS:

GAITS: Freedom and regularity.		1		
IMPULSION: Desire to move forward, elasticity of the steps, suppleness of the back, engagement of the hindquarters.		2		
SUBMISSION: Attention and confidence, lightness and ease of movements, acceptance of the bridle, lightness of the forehand.		2		
RIDER'S position and seat		1		
RIDER'S correct and effective use of the aids		1		
Harmony between rider and horse		1		

Further Remarks:

Subtotal: _____

Errors: (-) _____

Total Points: _____

÷ 250 Pts = % Score: _____

2011 First Level Test 1

No: _____

Purpose: To confirm that the horse, in addition to the requirements of Training Level, has developed the thrust to achieve improved balance and throughness and to maintain a more consistent contact with the bit. Introduce: 10m half circle in Flatwalk; 15m circle in Canter; lengthening of stride into the Runningwalk (must show lengthening, NOT quicker steps) and canter.

Conditions: Arena: Standard avg. Time: 5:00

Maximum Possible points: 290.

	Test	Directive Ideas	Coefficient			Remarks:
			Points	↓	Total	
1 A X	Enter Flatwalk Halt, Salute Proceed Flatwalk	Straightness on centerline and in halt; immobility; quality of flatwalk; willing, balanced transitions.				
2 C E-X X-B	Track left Half circle left 10meters Half circle right 10 meters	Bend and balance in turn; shape of half circles; straightness on centerline showing supple change of bend; quality of flatwalk.				
3 KXM M-C	Lengthen into Running walk Flatwalk	Moderate lengthening of frame and stride; quality and consistent tempo of running walk; willing, balanced transitions; straightness.				
4 C Before C C	Circle left 20 meters flatwalk, allowing the horse to stretch forward and downward Shorten the reins Flatwalk	Forward and downward stretch over the back into a light contact maintaining balance and quality of flatwalk; bend; shape and size of circle; smooth, balanced transitions.		2		
5 Between C & H	Medium walk	Willing, balanced transition; quality and regularity of flatwalk and medium walk.				
6 H-P P-F	Free walk Medium walk	Reach and ground cover of free walk allowing complete freedom to stretch the neck forward and downward; quality and regularity of medium walk; willing, balanced transitions; straightness.		2		
7 F A	Flatwalk Working canter right lead	Willing, calm, balanced transitions; quality of flatwalk and canter.		2		
8 E	Circle right 15 meters	Quality of canter; shape and size of circle; bend.				
9 M-P Between P & A	Lengthen stride in canter Develop working canter	Moderate lengthening of frame and stride in lengthened canter; quality and consistent tempo of canter; willing; balanced transitions; straightness.				
10 KXM X	Change rein Flatwalk	Willing, balanced transition; quality of canter and flatwalk; straightness.				

11 C	Working canter left lead	Willing, calm, balanced transition; quality of canter.		2		
12 E	Circle left 15 meters	Quality of canter; shape and size of circle; bend.				
13 F-R Between R & C	Lengthen stride in canter Develop working canter	Moderate lengthening of frame and stride; quality and consistent tempo of canter; willing, balanced transitions; straightness.				
14 C	Flatwalk	Willing, balanced transition; quality of flatwalk.		2		
15 HXF F-A	Lengthen stride into running walk Flatwalk	Moderate lengthening of frame and stride; quality and consistent tempo of running walk; willing, balanced transitions; straightness.				
16 A X	Down centerline Halt, Salute	Bend and balance in turn; straightness on centerline; willing, balance transition; immobility.				

Leave arena at A in walk on a long rein

COLLECTIVE MARKS:

GAITS: Freedom and regularity.		1		
IMPULSION: Desire to move forward, elasticity of the steps, suppleness of the back, engagement of the hindquarters.		2		
SUBMISSION: Attention and confidence, lightness and ease of movements, acceptance of the bridle, lightness of the forehand.		2		
RIDER'S position and seat		1		
RIDER'S correct and effective use of the aids		1		
HARMONY between rider and horse		1		

Further Remarks:

Subtotal: _____

Errors: (-) _____

Total Points: _____

÷ 290 Pts = % Score: _____

Purpose: To confirm that the horse, in addition to the requirements of Training Level, has developed the thrust to achieve improved balance and throughness and to maintain a more consistent contact with the bit. Introduce: Leg yield.

Conditions: Arena: Standard, Avg. Time: 6:00

Maximum possible points: 370

		Coefficient				
	Test	Directive Ideas	Points	↓	Total	Remarks:
1 A X	Enter flatwalk Halt, Salute Proceed flatwalk	Straightness on centerline and in halt; immobility; quality of flatwalk; willing, balanced transitions.				
2 C MXK K-R	Track right Lengthen stride into running walk Flatwalk	Bend and balance in turn; moderate lengthening of frame and stride; quality and consistent tempo of running walk; willing, balanced transitions; straightness.				
3 R-I	Half circle left 10 meters	Shape and size of half-circle; quality of flatwalk; bend				
4 X-K	Leg yield right	Quality and consistent tempo of flatwalk; alignment of horse, balance and flow in leg yield.		2		
5 A	Working canter left lead	Willing, calm, balanced transition; quality of canter.				
6 P	Circle left 15 meters	Quality of canter; shape and size of circle; bend.		2		
7 P-M	Lengthen stride in canter	Moderate lengthening of frame and stride; quality and consistent tempo of canter; balance; straightness.				
8 Between M & C	Develop working canter	Willing, balanced transition; quality and consistent tempo of canter.		2		
9 HXF X	Change rein Flatwalk	Willing, balanced transition; quality of canter and flatwalk; straightness.				
10 A	Medium walk	Willing, balanced transition; quality and regularity of walk.				
11 KXH H-C	Free walk Medium walk	Reach and ground cover of free walk allowing complete freedom to stretch the neck forward and downward; quality and regularity of medium walk; straightness; willing, balanced transitions.		2		
12 C	Flatwalk	Willing, balanced transition; quality of flatwalk.				
13 R Before R R-P	Circle right 20 meters flatwalk allowing the horse to stretch forward and downward Shorten the reins Flatwalk	Forward and downward stretch over the back into a light contact maintaining balance and quality of flatwalk; bend; shape and size of circle; smooth, balanced transitions.				
14 P-L	Half circle right 10 meters	Shape and size of half-circle; quality of flatwalk; bend.				

15 X-H	Leg yield left	Quality and consistent tempo of flatwalk; alignment of horse, balance and flow in leg yield.		2		
16 C	Working canter right lead	Willing, calm, balanced transition; quality of canter.				
17 R	Circle right 15 meters	Quality of canter; shape and size of circle; bend.		2		
18 R-F	Lengthen stride in canter	Moderate lengthening of frame and stride; quality and consistent tempo of canter; balance; straightness.				
19 Between F & A	Develop working canter	Willing, balanced transition; quality and consistent tempo of canter.		2		
20 KXM X	Change rein Flatwalk	Willing, balanced transition; quality of canter and flatwalk; straightness.				
21 HXF F-A	Lengthen stride into runningwalk Flatwalk	Moderate lengthening of frame and stride; quality and consistent tempo of running walk; willing, balanced transitions; straightness.				
22 A X	Down centerline Halt, salute	Bend and balance in turn; straightness on centerline; willing, balanced transition; immobility.				

Leave arena at A in walk on a long rein

COLLECTIVE MARKS:

GAITS: Freedom and regularity.		1		
IMPULSION: Desire to move forward, elasticity of the steps, suppleness of the back, engagement of the hindquarters.		2		
SUBMISSION: Attention, confidence, , lightness and ease of movements, acceptance of the bridle, lightness of the forehand.		2		
RIDER'S position and seat		1		
RIDER'S correct and effective use of the aids		1		
HARMONY between rider and horse		1		

Further Remarks:

Subtotal: _____

Errors: (-) _____

Total Points: _____

÷ 370 Pts = % Score: _____

2011 First Level Test 3

No: _____

Purpose: To confirm that the horse, in addition to the requirements of Training Level, has developed the thrust to achieve improved balance and throughness and to maintain a more consistent contact with the bit. Introduce: 10 meter circle at the flatwalk; change of lead through the flatwalk; and counter canter.

Conditions: Arena: Standard, Avg. Time: 6:00;

Maximum possible points: 310.

		Coefficient				
	Test	Directive Ideas	Points	↓	Total	Remarks:
1 A X	Enter flatwalk Halt, Salute Proceed flatwalk	Straightness on centerline and in halt; immobility; quality of flatwalk; willing, balanced transitions.				
2 C HXF F-K	Track left Lengthen stride into runningwalk Flatwalk	Bend and balance in turn; moderate lengthening of frame and stride; quality and consistent tempo of runningwalk; willing, balanced transitions; straightness.				
3 K-X	Leg yield right	Quality and consistent tempo of flatwalk; alignment of horse, balance and flow in leg yield.				
4 X X	Circle left 10 m Circle right 10mt	Shape and size of circles; Straightness on centerline showing supple change of bend; quality of flatwalk.		2		
5 X-H	Leg yield left	Quality and consistent tempo of flatwalk; alignment of horse, balance and flow in leg yield.				
6 C Before C C	Circle right 20m flatwalk, allowing the horse to stretch forward and downward Shorten the reins Flatwalk	Forward and downward stretch over the back into a light contact maintaining balance and quality of flatwalk; bend; shape and size of circle; smooth, balanced transitions.		2		
7 Between C & M	Medium walk	Willing, balanced transition; quality and regularity of flatwalk and medium walk.				
8 M-V V-K	Free walk Medium walk	Reach and ground cover of free walk allowing complete freedom to stretch the neck forward and downward; quality and regularity of medium walk; willing, balanced transitions; straightness.		2		
9 K A	Flatwalk Working canter left lead	Willing, calm, balanced transitions, quality of flatwalk and canter.				
10 A	Circle left 15m	Quality of canter; shape and size of circle; bend.				
11 F-M M-H	Lengthen stride in canter Working canter	Moderate lengthening of frame and stride; quality and consistent tempo of canter; willing, balanced transitions, straightness.		2		

12 HXX	One loop maintaining the left lead	Quality and consistent tempo of canter; balance; bend; shape and size of loop.				
13 FXH X	Change rein Change of lead through flatwalk	Willing, calm, balanced transitions; quality of canter and flatwalk; straightness.				
14 C	Circle right 15m	Quality of canter; shape and size of circle; bend.				
15 M-F F-K	Lengthen stride in canter Working canter	Moderate lengthening of frame and stride, quality and consistent tempo of canter; willing, balanced transitions; straightness.				
16 KXH	One loop maintaining the right lead	Quality and consistent tempo of canter; balance; bend; shape and size of loop.				
17 C MXK K-A	Flatwalk Lengthen stride into running walk Flatwalk	Moderate lengthening of frame and stride; quality and consistent tempo of running walk; willing, balanced transitions; straightness.		2		
18 A X	Down centerline Halt, Salute	Bend and balance in turn; straightness on centerline; willing balanced transition; immobility.				

Leave arena at A in walk on a long rein

COLLECTIVE MARKS:

GAITS: Freedom and regularity.		1		
IMPULSION: Desire to move forward, elasticity of the steps, suppleness of the back, engagement of the hindquarters.		2		
SUBMISSION: Attention and confidence, lightness and ease of movements, acceptance of the bridle, lightness of the forehand.		2		
RIDER'S position and seat		1		
RIDER'S correct and effective use of the aids		1		
HARMONY between rider and horse		1		

Further Remarks:

Subtotal: _____

Errors: (-) _____

Total Points: _____

÷ 310 Pts = % Score: _____

Endurance Riding

In endurance riding points count as follows: the first finishing TWH gets three points; the second finishing TWH gets two points; one point is awarded to any TWH that finishes the ride.

Additional points will be added to a horse's total points as follows: One for completion of a ride more than 100 miles in length; three for Best Conditioned of Ride; and three for 1st Overall Horse.

Rides must be at least 50 miles in length per day, up to a maximum distance of 200 miles in three days. Rides with steep elevation must be in 50 mile increments. The horses must be under the control of veterinarians experienced with horses and/or endurance riders. There may be no **minimum time limit**. The winner of the ride is the team that successfully completes the ride in the shortest time. Horses entered in the ride must be at least four years old.

English Pleasure

Horses shall enter the ring at a flat walk and when the gate is closed the Judge shall call for gaits in the order of flat walk, running walk, flat walk, and canter. The head motion of a walking horse is very important – if he isn't nodding, he isn't walking. Horses shall be worked both ways of the ring. Workouts may be held. English tack and attire are mandatory in this class. Snap brim hat or derby may be worn at the option of the exhibitor. Neatness and taste in attire is encouraged and should be a consideration of the Judge in the final judging. Whips or crops not to exceed four feet are permitted in English Pleasure.

Bits with shanks over 9 ½ inches are prohibited. Gag bits without shanks are prohibited. Extremely tight curb chains must be penalized. **Judges must severely penalize pumping of the reins in the canter.** Riders must ride with light reins in all three gaits. To be judged on true pleasure quality and performance of the horse and neatness and ability of the rider. Judges must require entries to back on the first line up for conformation judging. **Excessive speed should be penalized.** Do not sacrifice form for speed.

Classes may be specified as plantation, lite shod, trail pleasure, or country pleasure and may be designated for amateur or youth riders, etc. and if so designated affiliating HIO rules for that particular division will prevail.

Equitation

• Proper Saddle Seat, Walking Seat, Hunt Seat, or Stock Seat attire as per Rule Book. *The class sheet should specify whether the class is an English (Saddle Seat or Walking Seat), Hunt Seat, Stock Seat, Western Horsemanship, or Bareback class.*

• Class works both ways of the ring at all three gaits, lines up, at which time the judge shall ask each rider to back their horse.

• In Stock Seat and Western Horsemanship classes, the judge shall ask each rider to back their horse from the line-up and execute a 360 degree turn.

• All riders wearing English (Saddle Seat or Walking Seat) attire, shall be required to address their reins. Description of this maneuver follows: With reins in proper basic position, separate hands, out and down, so that the buckle closure of the reins rests on the horse's withers right in front of the saddle. Using rider's left hand, grasp both reins at buckle closure, with first two fingers gripping right rein. Left rein goes between ring finger and little finger. With right hand, grasp buckle and gently and neatly remove the slack from the reins by pulling upward and placing the bight on the off side. Rider's right hand grasps right rein while left thumb keeps reins closed.

• The judge shall ask for individual workouts from competitors he or she feels to be the top competitor plus two more than the number of ribbons.

• Performance of the horse shall in no way be considered except as it relates to the manageability, control and proper response to the equitation rider.

• In English classes a standard walking horse cutback saddle is required. Forward seat saddles are only permitted in Hunt Seat classes.

• In championship classes exhibitors may be asked to mount and dismount and/or change horses.

Suggested Work-Outs

• Figure 8 at the canter, with stopping the middle of the figure 8 to change leads.

• Perform the required gaits without stirrups.

Any patterns used should be posted 1 hour before class.



The following patterns are general examples, other patterns may be used.

Saddle Seat/Walking Seat Equitation Pattern 1

Begin at the mid-point of the in gate end of arena (A).

1. Canter to the left, around the curve and to the mid-point of the straightaway (B).
2. Without halting, make a turn to the right, and continue 1/4 of the way across the arena (C). Stop briefly.
3. Running Walk a figure 8, the first circle clockwise and the second circle counter clockwise. Stop briefly. (C).
4. Reverse and canter on the left lead to the rail (B). Turn left and continue to the end of the straightaway, around the curve and to the midpoint of the straightaway (A).

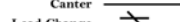
The workout has been completed - Thank You.

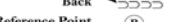

Walk -----
 Running Walk - - - - -
 Canter 
 Lead Change 
 Back 
 Reference Point (B)

Saddle Seat/Walking Seat Equitation Pattern 2

Begin at the mid-point of the in gate end of arena (A).



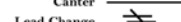

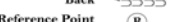
1. Begin test at Running Walk (A) to the right and perform a serpentine consisting of four half-circles.
2. Stop briefly and reverse (B).
3. Canter along the rail, around the curve to the midpoint of the straightaway (C).
4. Go directly into Running Walk, continue to the end of the straightaway, around the next curve and to the exit (A).

The workout has been completed - Thank You.

Walk -----
 Running Walk - - - - -
 Canter 
 Lead Change 
 Back 
 Reference Point (B)

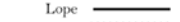
Stock Seat Equitation Pattern 1

1. Running Walk A to B
2. At B Lope a circle on the right lead, continue the lope to C
4. At C stop and back 4 steps



Walk -----
 Running Walk - - - - -
 Lope 
 Leg Yield 
 Lead Change 
 Back 
 Marker (B)
 Sidepass 

Stock Seat Equitation Pattern 2

Begin before A at a running walk

1. Running Walk A to B
2. At B, lope on the left lead and circle at B as shown. Stop facing B.
3. Turn 1/4 turn to the left.
4. Back one horse length.
5. Running Walk to C. Stop at C.

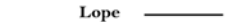
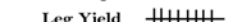
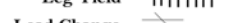
Follow the instructions of your ring steward.

Walk -----
 Running Walk - - - - -
 Lope 
 Leg Yield 
 Lead Change 
 Back 
 Marker (B)
 Sidepass 

Extreme/Sport

This division includes the following competitive events: Extreme Cowboy Race, Cowboy Mounted Shooting, Ranch Sorting, Team Penning, and Three Day/Three Phase Eventing. Points shall count as follows: the first finishing TWH gets three points; the second finishing TWH gets two points; one point is awarded to any TWH that competes in an event.

Participants in this division must submit an event program and a copy of the event results along with their versatility point books. Rules, judging, course layouts and guidelines as per the event standards are to be followed.

Hunter Hack

(a) The hunter hack horse should move in the same style as a working hunter. The class will be judged on style over fences, even hunting pace, flat work, manners and way of going. The head should not be carried behind the vertical, giving the appearance of intimidation, or be excessively nosed out, giving a resistant appearance.

(b) Horses are first required to jump two fences, two feet three inches (68.5 cm) to three feet (90 cm). However, if the jumps are set on a line they are recommended to be in increments of 12 feet (3.5 meters) but adjusted to no less than two strides. A ground line is recommended for each jump.

(c) Horses are then to be shown at a flat walk, running walk and canter both ways of the ring with light contact.

(d) At the discretion of the judge, contestants may be asked to hand gallop, pull up or back and stand quietly following the last fence.

(e) When necessary to split large classes by running more than one go round, finalists must both be re jumped and reworked on the flat.

(f) Placing for the class shall be determined by allowing a minimum of 70 percent for individual fence work and a maximum of 30 percent for work on the flat.

(g) Faults over fences will be scored as in TWH Over Fences class. Horses eliminated in over fence portion of the class shall be disqualified. Faults (to be scored accordingly, but not necessarily cause disqualification during the rail work) include:

- (1) Being on wrong lead
- (2) Excessive speed (any gait)
- (3) Excessive slowness (any gait)
- (4) Breaking gait
- (5) Failure to take gait when called
- (6) Head carried too low or too high
- (7) Nosing out or flexing behind the vertical
- (8) Opening mouth excessively
- (9) Stumbling

Hard hat, Hunt Seat equipment, snaffle, kimberwick or Pelham bit are required. Martingales, non weighted rubber bell boots, polo wraps, and splint boots are permitted.

Judged Pleasure Ride

Judged pleasure ride points shall count as follows: two points for TWH receiving first place in a working division; one point for second TWH in working division; 1/2 point for any TWH completing the ride.

Daily mileage for judged pleasure rides is less than 25 miles. Horses will be judged on ability to negotiate natural trail conditions and/or obstacles in a good trail-wise manner. They must demonstrate a free and quite way of going and must possess willingness to be ridden quietly in company with other mounts. Mounts must be asked to back. Contestants shall be responsible for manners of himself and mount. Ride on the right side of the road; pass other riders on the left. No tailgating! No racing!

Model/Halter

Model entries shall be shown in a bridle only. Entries may use either English or western equipment and attire, but not a combination of both.

Two-year-old and over stallions, mares or geldings shall be led into the ring and parked for judging. Conformation and conditioning are paramount. Horses must stand quietly. Unruly entries shall be dismissed from the ring. Unsoundness and/or transmittable faults or weaknesses must be penalized strongly in the final judging. A whip not to exceed four feet may be used in model classes.

Points will be accepted from halter or in hand classes.

Pleasure Driving

Performance of the horse shall be paramount and in no way overshadowed by equipment turnout. Horse to enter to the right (counter clockwise) and work both ways of the ring at the flat walk and running walk. Reverse to be executed on the diagonal at a walk or at the direction of the ringmaster. The horse is to line up, stand quietly, and back readily. Pleasure horse qualities are paramount. The horse should be judged with the same general qualities as the flat shod pleasure horse. The following suggestions to be use in judging: 70% manners, performance, condition style, and way of going; 20% on fit, condition and appropriateness of harness and vehicle; 10% on conformation and neatness of driver.

Snaffle bit is required; separate overcheck bit is optional. **Fine harness vehicles are prohibited in pleasure driving.**

Strongly recommended pleasure driving appointments and rules:

1. Harness is traditionally black leather with square patent leather blinkers, snaffle bridle with side check or overcheck, and running martingale.
2. A whip of length appropriate to the horse and cart.
3. Driving vehicle may be two or four wheel and of suitable appearance and safety. It is recommended that large classes be divided by show management. Breeching is not used with wire wheels and is recommended with wooden wheel vehicles. Only the driver is allowed in the cart. *Exception:* Youth driver may have one adult attendant in cart.
4. Neatly attired header may enter ring at line up for safety reasons and be allowed to unfasten overcheck and wipe horse off, but should not hold the horse. If the header holds the horse, it must be penalized.
5. Ladies shall wear conservative dress, blouse and skirt, shirt and jods with apron, saddle suit or day coat and jods. Men should wear business suit, saddle suit, sport jacket and slacks. Gloves are recommended, apron and hats are optional.
6. An uncontrollable horse must be immediately dismissed with assistance if necessary. The judge must excuse a competitor with unsafe vehicle or harness.
7. Show management may offer other classes such as antique or period, drive and ride, and obstacle.

Promotion

One point shall be awarded to the horse for participation in a live exhibition in which the Tennessee Walking Horse breed is officially recognized. This may include, but is not necessary limited to, horse expositions, parades, breed demonstrations, public clinics, and television appearances. Participants must submit event program or similar proof of participation with Versatility Point Books.

Points in promotion do not count toward champion, superior or supreme awards.

Showmanship At Halter

This class is designed to furnish the exhibitor an opportunity to demonstrate his ability to fit and show a conformation horse without the benefit of a bit and bridle. Judging shall be based on exhibitor ability, and no consideration shall be given to the horse except of grooming and fitting. Horses must be two year olds and over. Attire for this class may be either English or western, but not a combination of both, and must be clean and neat. The horse's halter should be either English or western, matching the attire of the exhibitor. Whips are not permitted in western showmanship.

How Judged:

Appearance of exhibitor (10 points)

1. Suitable English or western attire, but not a combination.
2. Attire and person – neat and clean.

Appearance of Horse (40 points)

1. Condition and thriftiness (15 points)
2. Grooming (15 points)
 - Hair coat clean, well brushed.
 - Mane and tail free of tangles and clean.
 - Hoofs trimmed or shod properly, clinched neatly and hooves polished.
3. Trimming (5 points)
 - Inside of ears trimmed.
 - Bridle path trimmed.
 - Long hair on jaw, legs and pasterns trimmed.
4. Tack (5 points)
 - Tack (halter and lead) should be neat, clean, and in good repair.

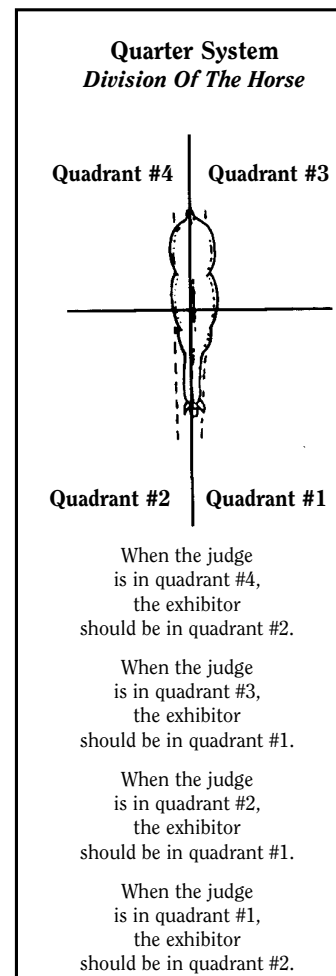

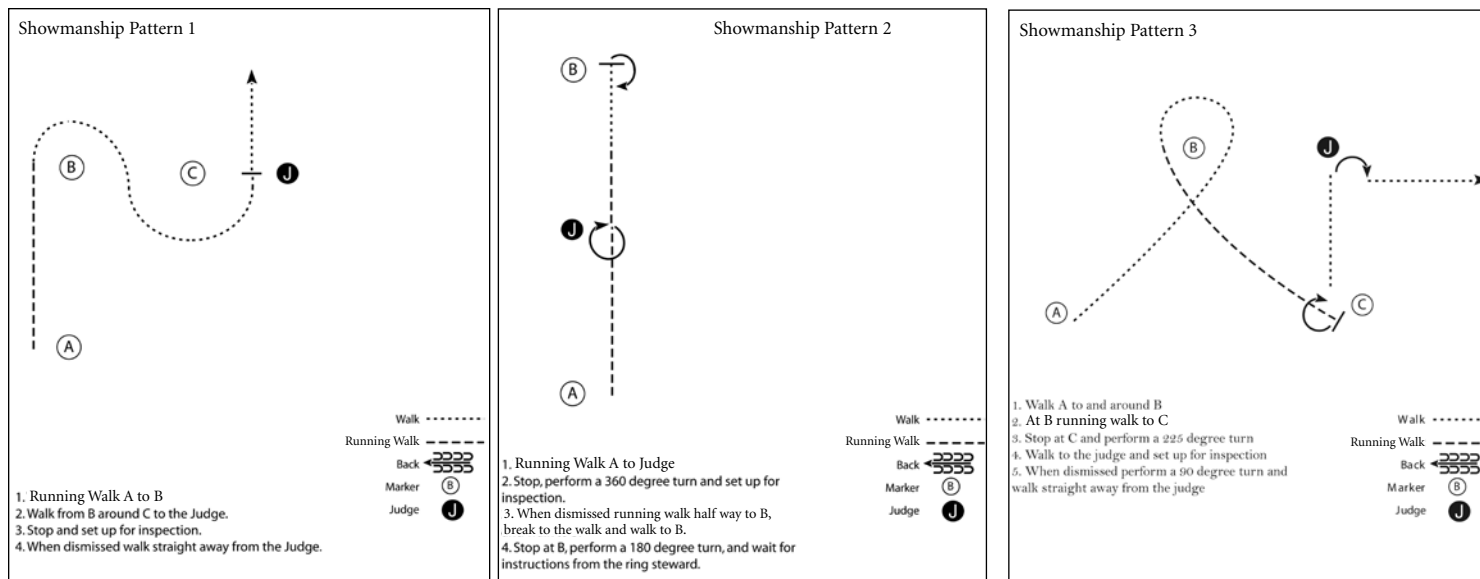

Pattern should be posted at least 1 hour before class. Above patterns are general examples, other patterns may be used.

Showing Horse in Ring (50 points)

Leading (15 points)

- Enter the ring in the direction indicated by the ring steward and walk until the Judge requests that the horses line up for inspection. Walk on the horse's left side, holding the lead shank in the right hand, near the halter. The remaining portion of the lead shank shall be held neatly and safely in the left hand. A tightly coiled or rolled lead shank, or one with fingers inserted or laced through the coils, will be considered a fault in showmanship. Animal should lead readily at the walk and running walk.

- After the judge has lined up the class, each exhibitor will be requested to move his or her horse individually. When moving the horse, the exhibitor should be sure that the judge gets a clear unobstructed view of the horse's action. Allow the horse sufficient lead so that he can move freely in a straight line with his head carried at a height appropriate to his conformation. Lead the horse from his left side, with his throatlatch even with the exhibitor's shoulder. Lead the horse the required distance, stop and set the horse up. At the judge's signal, turn to the right around the horse, turning him directly over his hocks with his hind feet staying nearly in place.

- If the exhibitor is asked to back his horse, he should back him smoothly, one step at a time, as straight as possible for one body length. Do not change hands on the lead shank and use a press-and-release technique to ask the horse to back.

Posing horse (15 points)

- When posing the horse, the exhibitor should stand toward the front facing the horse with his or her toes pointed toward the horse's eye or neck. The exhibitor should not stand directly in front of the horse but should always stand in a position where he or she can keep an eye on the judge.

There are two presentation styles used by exhibitors, the old style and the quarter system. In the old style, the exhibitor always stays on the side of the horse opposite the judge. This is a way to keep from blocking the judge's view of the horse.

With the quarter system, the horse is divided into four section by drawing one imaginary line down his back and another across his middle. When the judge is looking at either hindquarter of the horse, the exhibitor stays on the same side as the judge, with his or her toes pointed toward the horse's eye or neck. This is where the two styles differ. When the judge looks at either front quarter, the exhibitor crosses to the opposite side of the horse. Both showmanship styles are the same here.

When posing the horse, do most of the showing with the lead shank. The exhibitor should not touch the horse with his or her hand, never change hands on the lead shank or kick the horse's leg into position.

- Never crowd the exhibitor next to you when in a side by side position. Never crowd the exhibitor in front when lined up head to tail.

- Always leave a horse's length between you and the next horse.

Poise, Alertness and Merits (20 points)

- Keep alert and be aware of the position of the judge at all times. Do not be distracted by persons or things outside the ring.

Timed Speed Events

Timed Speed Events include any class where the final time is the sole factor in determining the class placings. The events in which you would be able to compete and count points include the following:

Barrel Racing. In these classes, it is mandatory to wear appropriate western attire, including a shirt with long sleeves and collar, western hat, helmets and western boots. The hat must be on the contestant's head when the contestant enters the arena. A five second penalty will be assessed if the hat or helmet is not on the contestant's person the entire time the contestant is in the arena. (Hats held on the body by a stampede string are allowed.)

(a) Western type equipment must be used in barrel racing classes. The use of skid boots, splint boots and polo wraps is permitted. Mechanical hackamores may be used, however, the judge may disqualify a horse that is using shanks that are felt to be too severe. The judge may prohibit the use of bits or equipment that he considers severe. Cavasons, whips, crops or bats of any kind are prohibited.

(b) The course must be measured exactly. If the course is too large for the available space, then the pattern should be reduced five yards at a time until the pattern fits the arena. Remember to leave adequate space between barrels and any obstacle. The distance from barrel number three to the finish line need not be reduced five yards at a time if there is sufficient room for the horse to stop.

(c) When measuring the area for the barrel course, remember to leave ample room for the horses to complete their turns and to stop at the finish.

(d) A clearly visible starting line must be provided. Barrel Racing is a timed event. An electric timer or at least two watches will be used, with the time indicated by the electric timer or the average time of the watches used by the official timers to be the official time.

(e) The contestant is allowed a running start. Timing will begin as soon as the horse's nose reaches the starting line and will be stopped when the horse's nose passes over the finish line.

(f) At a signal from the starter, the contestant will run to barrel one, pass to the left of it, and complete an approximately 360 degree turn around it; then go to barrel number two, pass to the right of it, and complete a slightly more than 360 degree turn around it; then go to barrel number three, pass to the right of it, and do another approximately 360 degree turn around it, and then sprint to the finish line.

(g) This barrel course may also be run to the left. For example, the contestant will start by running to barrel number two, turning to left around this barrel then to barrel number one, turning to the right, then to barrel number three, turning again to the right, followed by the final sprint to the finish line.

(h) Knocking over barrels will cause a five second penalty per barrel. A contestant may touch the barrel with his hand in Barrel Racing. A contestant that breaks the pattern or fails to follow the course will be disqualified.

(i) In the event of a tie, the horse declared the winner in the runoff must re-run the pattern within two seconds of its original time or the runoff must be held again.

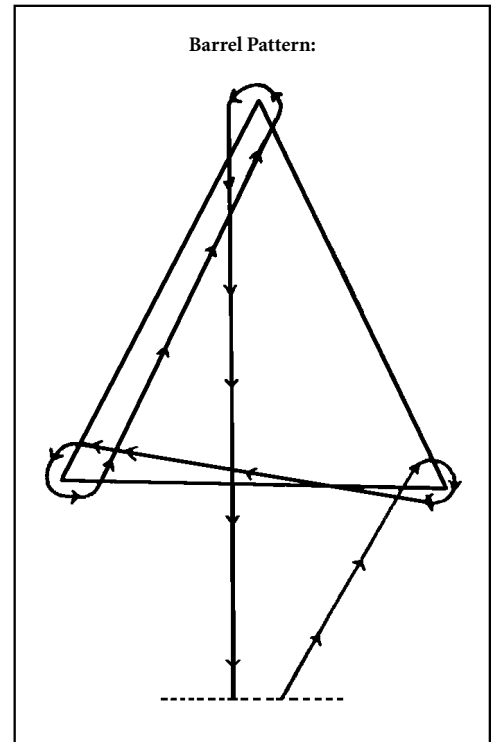

Catalog Race. In these classes, it is mandatory to wear appropriate western attire, including a shirt with long sleeves and collar, western hat and western boots. The hat must be on the contestant's head when the contestant enters the arena. A five second penalty will be assessed if the hat or helmet is not on the contestant's person the entire time the contestant is in the arena. (Hats held on the body by a stampede string are allowed.)

(a) Western type equipment must be used in catalog racing classes. The use of skid boots, splint boots and polo wraps is permitted. Mechanical hackamores may be used, however, the judge may disqualify a horse that is using shanks that are felt to be too severe. The judge may prohibit the use of bits or equipment he may consider severe. Cavesons, whips, crops or bats of any kind are prohibited.

(b) Catalog racing is a timed event. Each contestant will begin from a running start, and time will begin and end as the horse's nose crosses the line. (A clearly visible starting line will be provided.) An electric timer or at least two (2) watches will be used, with the time indicated by the electric timer or the average time of the watches used by the official timers to be the official time.

(c) Prior to crossing the start line, each contestant will be given a page number. The contestant will then race across the start line to a catalog sitting on a table 100 feet from the start line. Rider will come to a halt, dismount, find the page in the catalog, remove it, remount, race back across the start line, and hand the page to the ringmaster for verification.

(d) Disqualification will result if rider takes the wrong page from the catalog.

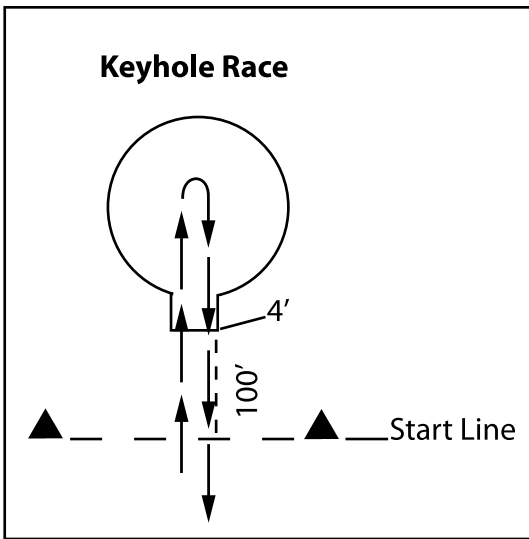

Keyhole Race. In these classes, it is mandatory to wear appropriate western attire, including a shirt with long sleeves and collar, western hat and western boots. The hat must be on the contestant's head when the contestant enters the arena. A five second penalty will be assessed if the hat or helmet is not on the contestant's person the entire time the contestant is in the arena. (Hats held on the body by a stampede string are allowed.)

(a) Western type equipment must be used in keyhole racing classes. The use of skid boots, splint boots and polo wraps is permitted. Mechanical hackamores may be used, however, the judge may disqualify a horse that is using shanks that are felt to be too severe. The judge may prohibit the use of bits or equipment he may consider severe. Cavesons, whips, crops or bats of any kind are prohibited.

(b) Keyhole racing is a timed event. Each contestant will begin from a running start, and time will begin and end as the horse's nose crosses the line. (A clearly visible starting line will be provided.) An electric timer or at least two (2) watches will be used, with the time indicated by the electric timer or the average time of the watches used by the official timers to be the official time.

(c) This event tests the ability of the rider to go through a four foot opening, turn around within a 16 foot diameter circle and run out again through the four foot opening. The pattern should be drawn with lime or flour 100 feet from the starting line. A small mound of dirt covered in lime or flour should mark either side of the four foot opening.

(d) The contestant is disqualified for stepping on or outside the markings for the circle or the opening and for separation of rider and horse during the timing period.

Pole Bending. In these classes, it is mandatory to wear appropriate western attire, including a shirt with long sleeves and collar, western hat and western boots. The hat must be on the contestant's head when the contestant enters the arena. A five second penalty will be assessed if the hat or helmet is not on the contestant's person the entire time the contestant is in the arena. (Hats held on the body by a stampede string are allowed.)

(a) Western type equipment must be used in the pole bending class. The use of skid boots, splint boots and polo wraps is permitted. Mechanical hackamores may be used, however, the judge may disqualify a horse that is using shanks that are felt to be too severe. The judge may prohibit the use of bits or equipment he may consider severe. Cavesons, whips, crops or bats of any kind are prohibited.

(b) Pole Bending is a timed event. Each contestant will begin from a running start, and time will begin and end as the horse's nose crosses the line. (A clearly visible starting line will be provided.) An electric timer or at least two (2) watches will be used, with the time indicated by the electric timer or the average time of the watches used by the official timers to be the official time.

(c) The pole bending pattern is to be run around six poles. Each pole is to be 21 feet apart and the first pole is to be 21 feet from the starting line. Poles will be set on top of the ground, six feet in height, and with no base more than 14 inches in diameter.

(d) A horse may start either to the right or to the left of the first pole and then run the remainder of the pattern accordingly. (See pattern.)

(e) Knocking over a pole, touching the pole with the contestant's hand will cause a five second penalty. Failure to follow the course will cause disqualification.

(f) In the event of a tie, the horse declared the winner in the runoff must re-run the pattern within two seconds of its original time or the runoff must be held again.

Stake Race. In these classes, it is mandatory to wear appropriate western attire, including a shirt with long sleeves and collar, western hat and western boots. The hat must be on the contestant's head when the contestant enters the arena. A five second penalty will be assessed if the hat or helmet is not on the contestant's person the entire time the contestant is in the arena. (Hats held on the body by a stampede string are allowed.)

(a) Western type equipment must be used in stake racing classes. The use of skid boots, splint boots and polo wraps is permitted. Mechanical hackamores may be used, however, the judge may disqualify a horse that is using shanks that are felt to be too severe. The judge may prohibit the 'x' marks the position of upright poles. The pattern may be run from the left (as shown at left), Or, the pattern may be run from the right (as shown at right).

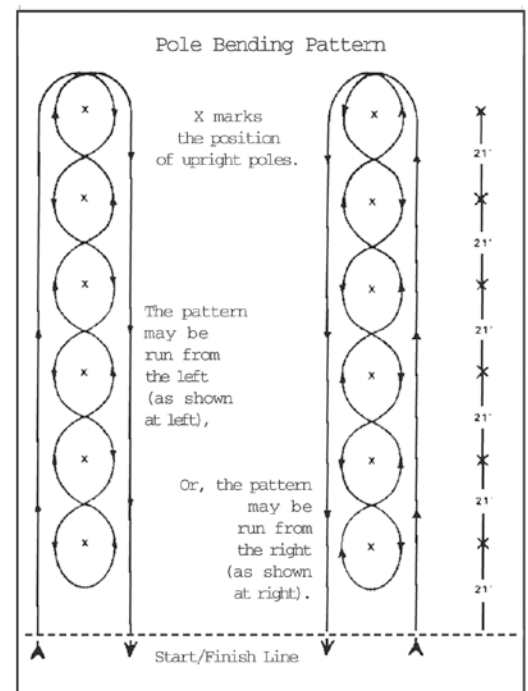

(b) Stake racing is a timed event. An electric timer or at least two (2) watches will be used, with the time indicated by the electric timer or the average time of the watches used by the official timers to be the official time.

(c) The stake race uses two stakes that are set 100 feet apart. The start/finish line is drawn midway between the stakes. Contestant starts from stop.

(d) Pattern may be run from the left or right hand to start. The Stake Race is a sequence of figure-eight patterns. The course begins with the horse crossing the start line with all four feet; make a turn to the left or right; proceeds to an opposite turn around the first stake; alternates to the first direction turn around the second stake; alternates to the opposite turn around the third stake and across the center line to finish.

(e) Proper sequence of figure-eight patterns must be completed. A five second penalty will be assessed for each stake/pole knocked over.

(f) Rider will be disqualified if the proper sequence of the figure-eight pattern is broken.

Other speed-type classes may count under this division and will be reviewed on a case by case basis.

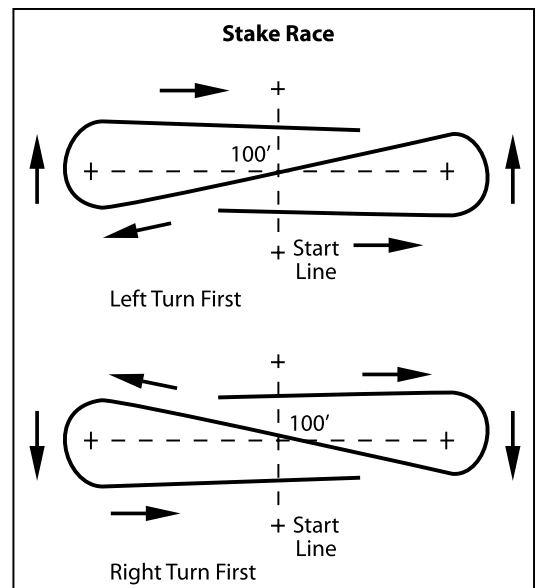

Trail Obstacle

Course should be posted prior to class.

It is suggested that this class be divided into youth and adult classes where there are sufficient entries. The judge may grade each obstacle subtracting points for faults, refusals, excessive time, etc. Plus and minus points may also be used for each obstacle. The judge should request a contestant move on to the next obstacle if too much time is spent on one obstacle.

Individual horse and exhibitor will negotiate an obstacle course consisting of six obstacles, three of which are mandatory, listed below. Final consideration of the judge will include quality and smoothness of performance of the horse and neatness and ability of exhibitor. The ideal trail horse will negotiate the course with surefootedness; looks at the obstacles, but does not hesitate, yet does not rush along the course; moves willingly without excessive urging of exhibitor. Horse should show willingness to stand quietly on the bridge and not rush off. At the gate, the obstacle is not complete unless the gate is closed and should be judged accordingly. Horse should position himself at all times to enable the exhibitor to keep a hand on the gate until the gate is closed.

Entry may be either English or Western, but not a combination of both. Western exhibitor must hold reins in one hand (the exception being a horse five or under wearing a bosal or ring snaffle) and should not be changed during the performance except while working the gate, if necessary. English entries may be ridden with both hands on the reins.

A time limit may be set for the course; however, the time itself will have no bearing on the final placement except as a limit for course completion. The use of skid boots, splint boots, polo wraps or other approved leg protection devices is permitted. Any type hackamore is not permitted with the exception of a bosal.

Mandatory Obstacles (may choose any three):

- (a) Opening, passing through and closing gate (one that does not endanger horse or rider).
- (b) Cavaletti (ride over at least four logs spaced on the ground).
- (c) Ride over wooden bridge (may be plywood set so as to simulate sound and appearance of bridge).
- (d) Ground tie horse, walking a full circle around horse.

Some Suggested Optional Obstacles:

- (a) Back horse through "L" shaped course (logs or bales of hay suggested).
- (b) Water hazard.
- (c) 360 degree Hindquarter or forehand turn performed inside four poles placed 6-8 feet in width.

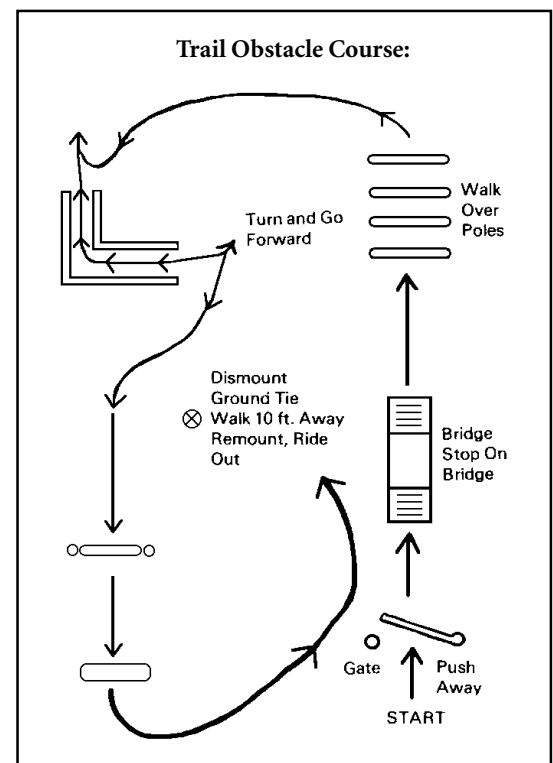

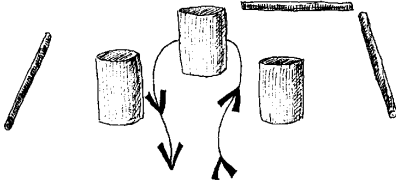

BACK THROUGH
Three oil drums or nail kegs, 30" to 36" apart; may be confined by poles as shown.

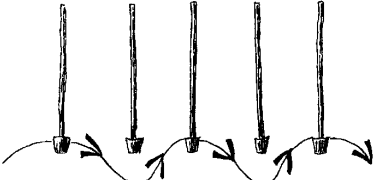

SERPENTINE
6" laths set in cement filled coffee cans close together for walk through or back through.



GROUND THROW
Canvas, plastic, animal skin, etc.; may be used in conjunction with other walk overs.

These obstacles are illustrated as guides. Imagination may be used for modifications and combinations. Courses should always be designed with the safety of the horse/rider in mind.

Basic Trail Obstacles:

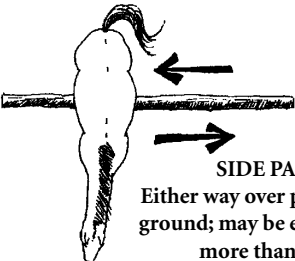

SIDE PASS
Either way over pole on the ground; may be elevated no more than 12".



STEP OVER
12" high, may be ridden over or led over; two may be used as an "in and out"

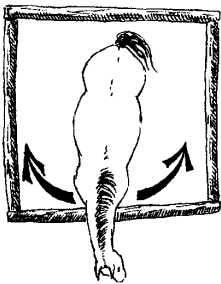

HINDQUARTER or FOREHAND TURN
360 degree turn inside four poles placed 6-8 feet in width.

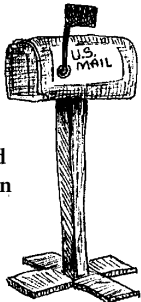

MAILBOX
May be used as a mounted obstacle, or in combination with a ground tie.

Basic Trail Obstacles:

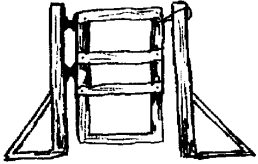

GATE
50" to 60" high; should swing both ways.



BRIDGE
18" to 24" high with sloping ramps; at least 36" wide; at least 6' long.



WALK OVERS
Railroad ties, jump poles, natural rails, etc.

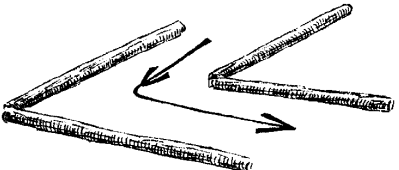

BACK THROUGH: "L" or "Z" SHAPED
Poles or bales of hay or straw on edge are suitable and must be a minimum of 30" in width; elevation must be no more than 24".

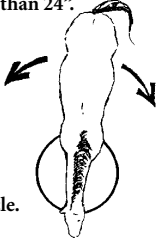

FOREHAND TURN
360 degree turn with forefeet in a large circle.

Trail Obstacle Scoring and Penalties

(a) Scoring will be on the basis of 0-100, with 70 denoting an average performance. Each obstacle will receive an obstacle score that should be added or subtracted from 70 and is subject to a penalty that should be subtracted. Each obstacle will be scored on the following basis, ranging from plus 1 1/2 to minus 1 1/2: -1 1/2 extremely poor, -1 very poor, -1/2 poor, 0 correct, +1/2 good, +1 very good, +1 1/2 excellent. Obstacle scores are to be determined and assessed independently of penalty points. Penalties should be assessed per occurrence as follows:

(b) The following deductions will result:

One-half (1/2) Point

- each tick of log, pole, cone, plant, or any component of the obstacle

One (1) Point

- each bite of or hit of or stepping on a log, cone, plant or any component of the obstacle
- incorrect or break of gait at flat walk or running walk for two strides or less
- both front or hind feet in a single-strided slot or space at a flat walk or running walk
- skipping over or failing to step into required space
- split pole in lope-over
- incorrect number of strides, if specified

Three (3) Point

- incorrect or break of gait at flat walk or running walk for more than 2 strides

- out of lead or break of gait at lope (except when correcting an incorrect lead)
- knocking down an elevated pole, cone, barrel, planet, obstacle, or severely disturbing an obstacle
- stepping outside of the confines of, falling or jumping off or out of obstacle with designated boundaries with one foot once the foot has entered obstacle; including missing one element of an obstacle on a line of travel with one foot

Five (5) Point

- dropping slicker or object required to be carried on course
- first or second cumulative refusal, balk, or evading an obstacle by shying or backing
- letting go of gate or dropping rope gate
- use of either hand to instill fear or praise
- stepping outside the confines of, falling or jumping off or out of an obstacle with designated boundaries with more than one foot once the foot has entered obstacle; including missing one element of an obstacle on a line of travel with more than one foot
- blatant disobedience (including kicking out, bucking, rearing, striking)
- faults, which occur on the line of travel between obstacles, scored according to severity:
 - head carried too high
 - head carried too low (tip of ear below the withers)
 - over-flexing or straining neck in head carriage so the nose is carried behind the vertical
 - excessive nosing out
 - opening mouth excessively
- holding saddle with either hand

Disqualified 0 – Score

- performing the obstacle incorrectly or other than in specified order
- no attempt to perform an obstacle
- equipment failure that delays completion of pattern
- entering or exiting an obstacle from the incorrect side or direction
- working obstacle the incorrect direction; including overturns of more than 1/4 turn
- riding outside designated boundary marker of the arena or course area
- third cumulative refusal, balk, or evading an obstacle by shying or backing
- failure to ever demonstrate correct gait between obstacle as designated
- failure to follow the correct line of travel between obstacles

TWH Over Fences

Fences should simulate obstacles found in the hunting field (poles and rails, brush, wall, gates and coops, etc.) and have the appearance of being solid. Post and rail fences must have a minimum of two rails per fence, excluding ground line. The maximum space between rails should not be more than 12 inches. A ground line (pole) is recommended for all fences. (A pole as long as the jump that is laid on the ground just below the jump or approximately 18 inches from the base on the approach side.)

Jumper fences such as bull's eyes, stripes and spreads of over four feet are prohibited. Wings may be used and if so must be 30 inches wide and 12 inches higher than the top of the fence. A combination fence such as an "in and out" may be used. They count as one fence. Both a and b should be the same height and 24 to 26 feet is a suggested distance between them used in a ring.

A simple fence such as post and rail should be used for the first obstacle on any course. When setting up the distance between single fences, the distance is divided by increments of 12 feet, 24 feet, etc.

Exhibitors should have the opportunity to walk the course without their horse to check striding prior to commencement of the class. A warm-up of two or more fences must be available. The course does not have to be in the ring, but may be set up to the side of the ring, becoming an outside course.

A full circle before starting the course is customary and sets the hunter pace which is carried throughout the course. A circle may be made at the finish. A course should have two directions with one change of leads. Jumps may range from a minimum two feet to a maximum three feet in height. A fence must be at least 12 feet wide or have wings at least 30 inches wide that are 12 inches higher than the fence (pen jumps excluded).

A course consists of eight jumps, of at least four different obstacles. An obstacle may be jumped more than once.

Way of going of a consistent, even, safe hunter pace, manners and soundness are to be emphasized. Excessive speed will be penalized.

Hunter Pace is defined as a longer flowing canter with enough speed and impulsion to meet and take each jump giving the appearance of grace and ease. It should be maintained throughout the course, including the beginning and the ending circle.

The ideal TWH Hunter Over Fences will meet each fence at the proper takeoff spot for a perfect arc over the obstacle. Its jump will be snappy and athletic with the forelegs held at or above a parallel line to the ground. The joints of the forelegs are tucked tightly in front of the chest and the neck and back arched over the fence.

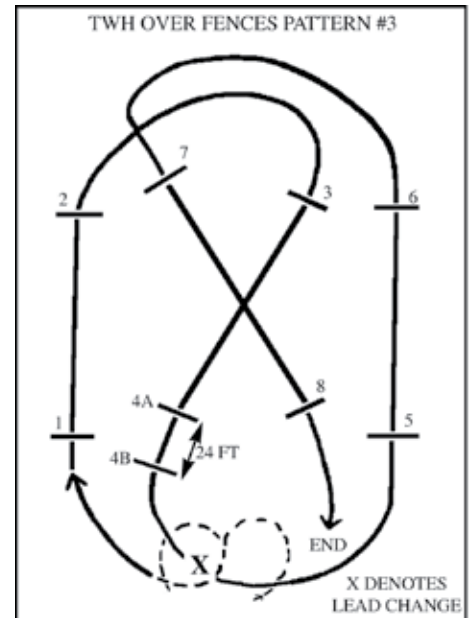
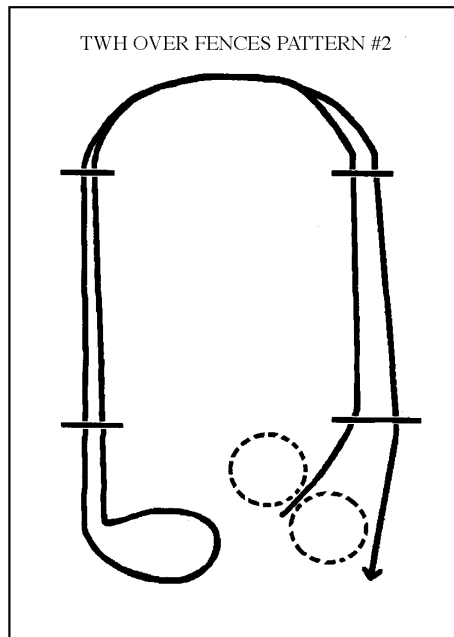
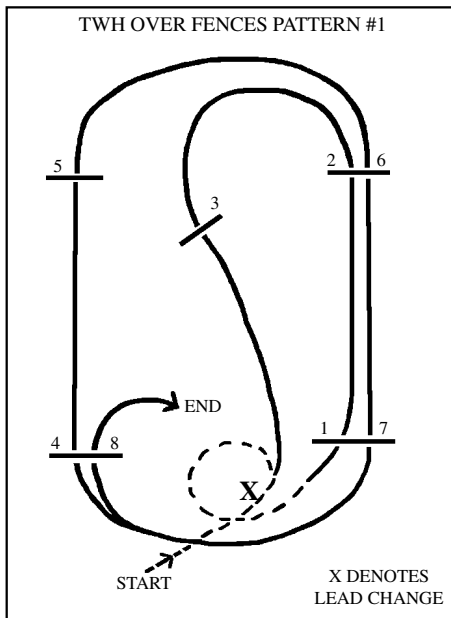

Faults are knockdowns, extra circles, and refusals. **Eliminations** are **third refusals**, off course, fall of horse or rider, jumping out of order, jumping before jump or when jumps are reset.

Hardhat, Hunt Seat equipment, snaffle, Kimberwick or Pelham bit are required. Martingales, non-weighted bell boots, polo wraps, and splint boots are permitted in TWH Over Fences classes.

Two-Gaited TWH Pleasure

The two-gaited Tennessee Walking Horse pleasure class (no canter required) is designed for the horse and rider who have not yet mastered the canter. All entries must be registered Tennessee Walking Horses. Classes may be specified as plantation, lite shod, trail pleasure, or country pleasure and may be designated for amateur or youth riders, etc. and if so designated affiliating HIO rules for that particular division will prevail.

Untimed Game Events

Untimed Game Events include any game class where skill is the factor in determining class placings. The events in which you would be able to compete and count points include the following:

Water Glass (*rules also apply for Champagne Glass, Beer Glass, Soda Glass, etc.*). Each exhibitor enters the ring holding a full glass of water and performs the flat walk and running walk both ways of the ring. Horses are required to show a noticeable change in speed between the flat walk and the running walk. Judge may disqualify any horse that does not demonstrate this change in speed. The exhibitor with the most water left in his glass wins the class. In case of a tie, a canter may be called for. One hand only is to be used in holding the glass, out and away from the body of horse and exhibitor. The hand may not cover the top of the glass nor may any of the fingers wrap around the top of the glass.

Ride-A-Buck. Each exhibitor enters the ring riding bareback with a dollar bill under one or both knees and performs that flat walk and running walk both ways of the ring. A canter may be called for at the judge's discretion. Horses are required to show a noticeable change in speed between the flat walk and the running walk. Judge may disqualify any horse that does not demonstrate this change in speed. The last exhibitor to have a dollar bill under their knee wins the class.

Egg and Spoon. Each exhibitor enters the ring holding a spoon with an egg balanced on it and performs the flat walk and running walk both ways of the ring. A canter may be called for at the judge's discretion. Horses are required to show a noticeable change in speed between the flat walk and the running walk. Judge may disqualify any horse that does not demonstrate this change in speed. The last exhibitor to be holding their egg is the winner of the class. One hand only is to be used in holding the spoon with egg, out and away from the body of horse and exhibitor. Spoon must be held by the handle and the exhibitor's hand must never touch or wrap around the egg.

Ribbon Race. The ribbon race is an event involving two mounted competitors who carry a piece of crepe paper ribbon between them. The goal of the event is to not break the ribbon or let go of it. The last team to be holding an intact ribbon is the winner. The placings will be assigned in reverse of the order of teams that loose or break their ribbon (example - the first team to loose or break their ribbon will receive the last tie, the second team to loose or break their ribbon will receive the second to last tie, etc.). The judge may call for any or all gaits and patterns to be done at any gait. The length of the ribbon may be shortened at the discretion of the judge as the class proceeds. Any team may be disqualified if they do not follow gait changes or patterns as called by the judge. Points for the Versatility Program may be earned by both members of the team and will be determined by the placing of the team and the number of teams in the class as per "How Points Are Awarded" (page 3 of the TWHBEA Versatility Rule Book 2010 and Beyond).

Other games-type classes may count under this division and will be reviewed on a case by case basis.

Versatility Driving

The events in which you would be able to compete and count points are as follows:

Heritage Driving. To be judged 50% on performance, 20% on apparel of whip and personnel, 15% on vehicle, and 15% on harness.

Apparel. The required costumes should be dated on the vintage of the vehicle, i.e., formal with a formal carriage and sporting with a sporting vehicle. The exhibitor must wear a hat, gloves, lap robe or apron and carry a whip at all times.

Vehicle. The antique type vehicles should be sound and safe for driving, the wheels and spokes tight. The horse should be appropriate to the vehicle and there should be a pleasing balance between the two.

Harness. The harness should be in good repair, clean, and fit properly. All metal furnishings should match, be secure, and polished.

Combination/Drive and Ride. Single horse to be shown first as a plantation driving horse, and then under saddle at a walk, running walk, and canter. To be judged fifty percent (50%) on performance, manners, way of going and suitability in harness; and fifty percent (50%) on performance, manners, and way of going under saddle. To be driven and ridden by the same person. Snaffle bit required.

Concours D' Elegance. The word "elegance" is the essence of this competition. The winner will be the turnout that presents the most elegant effect (vehicle, harness, appointments of horses, driver, passengers, groom, etc.). Performance will not be judged unless it detracts from the elegance of the turnout. Snaffle bit required.

Obstacle Driving/Time Competition. To be driven over a prescribed course consisting of no more than 20 obstacles. Faults on the course will be scored as penalty seconds. The winner will be determined by adding the penalty seconds incurred on the course to the time taken to complete the course. Ties for first place will be decided by a drive-off.

Participation:

1. A horse may not be entered more than once in the same class unless one driver is an adult and one driver is a youth
2. A youth under 14 years of age may have an adult as a passenger but the adult must not touch the reins or assist the driver in any way. Such action would be cause for elimination.

Course:

1. Drivers must be allowed time to walk the course prior to the start of a class and inspect each obstacle. Horses are not allowed on course before the competition.
2. The course and time allowed is usually determined by show management, an average course consists of six obstacles to be completed in four minutes or less.
3. Time allowed is for the entire course and will be used only to break a tie. Failure to complete the course in the prescribed time is an elimination.
4. Timing starts and ends when competitor crosses starting and finishing line.
5. Obstacles will be marked by a pair of cones with a ball atop each one.
6. Distance between the pair of cones is usually six inches wider than the widest asle.
7. If a ball is dislodged the penalty is an obstacle knocked over.

Penalties:

- | | |
|--|-------------|
| • Dislodging a ball | 2 points |
| • Knocking over any element of an obstacle | 2 points |
| • Breaking into a canter (each offense) | 2 points |
| • Disobedience: | |
| First Offense | 5 points |
| Second Offense | 10 points |
| Third Offense | Elimination |
| • Taking an obstacle out of sequence | Elimination |
| • Exceeding time limit | Elimination |
| • Failure to cross start and finish lines | Elimination |
| • Receiving outside assistance | Elimination |

Description of Disobedience:

1. A Run-Out comprises evading or passing an obstacle
2. A Refusal comprises stopping or reining back before an obstacle
 - a. Stopping before an obstacle followed IMMEDIATELY by driving cleanly though is not penalized.
 - b. If halt is prolonged or if the horse takes even a single step backward, a refusal is incurred.
3. Rearing or Balking

In this system of penalty points the competitor with the lowest number of points is the winner!

Obstacle Driving/Gambler's Choice. To be driven and timed over a course of unnumbered obstacles each carrying a specific point value according to its degree of difficulty. Each exhibitor will attempt to amass as many points as possible in a prescribed time and may negotiate the obstacles in any order. However, the same obstacle cannot be done continuously. When the allowed time has elapsed, a whistle will be blown and the exhibitor must then cross the finish line. The winner will be determined on a high point basis. Time will decide ties. If a tie occurs in both points and time for first place, the winner will be decided by a drive-off.

Western Pleasure

Entry shall reflect suitability of the TWH as a western working horse, exhibiting qualities suitable for ranch work. The western pleasure horse works quietly exhibiting an exceptionally smooth, comfortable ride without excessive action or animation. The horse should be semi-collected and ridden with a loose rein. The head set should be natural – neither too high nor too low, neither excessively nosed out or over flexed at the poll. Reins must be held in one hand and cannot be changed during performance. When using split reins, a hand around the reins or index finger between reins is permitted, but the free hand is not allowed to touch the reins.

Romal reins mean an extension of braided material attached to closed reins. This extension is allowed to be carried in the free hand with approximately a 16 inch spacing between the reining hand and the free hand holding the Romal. The Romal shall not be used forward of the cinch or used to signal or cue the horse in any way. When using a romal, the rein hand should be around the reins. Fingers between the reins are not permitted. The use of hobbles and a riata on the saddle are appropriate when using romal reins.

In western pleasure classes, horses shall perform the flat walk, running walk, and lope both ways of the ring and should be reversed away from the rail.

While the horse is in motion, the rider's hands shall be clear of horse and saddle. The Judge may call for a halt on the rail to test for quietness. Horse must stand quietly and back readily with head in normal position and mouth closed. (At the discretion of Judge or Show Management, the horse may be asked to back clear of the line-up and do a 360 degree neck reined turn to either the right or the left, rider's discretion.) The horse should wear a western bridle with no cavesson and a bit with shanks not to exceed 9 ½ inches. A snaffle bit or bosal may be used on horses five years old and under. The rider may use two hands on the reins when using a snaffle bit or bosal. Western tack and attire including hat, boots and long sleeved shirt are mandatory. Chaps and spurs may be worn at the option of the rider. Australian stock and endurance saddles are not permitted.

Classes may be specified as plantation, lite shod, trail pleasure, or country pleasure and may be designated for amateur or youth riders, etc. and if so designated affiliating HIO rules for that particular division will prevail.

Western Riding

Purpose: A western riding horse is a sensible, free and easy-moving, well-mannered animal which can provide quiet, comfortable and pleasant rides at a walk, running walk, and lope over trails and in open country through and over obstacles, and with the handiness and athletic ability to do a variety of jobs on the farm or ranch. Western riding is neither a stunt nor a race and is not to be confused with an equitation or horsemanship class in which the exhibitor is judged, nor confused with a western plantation rail class. Western riding is an event where the horse is judged on quality of gaits, lead changes at the lope (flying lead changes), response to the rider, and disposition.

Tack: Silver tack may be used but shall not be given preference over good working equipment. Saddle is to be a western style and must fit both animal and rider. Bridle is to be western style. A curb may be either leather or chain, but must be at least 1/2 inch wide and lay flat against the animal's jaw. Split or romal reins must be used. Junior horses five years old and under may be ridden in a snaffle bit or bosal using two hand on the reins.

Optional Tack: Breast strap, hobbles on saddle when romal is used, skid boots, splint boots, polo wraps, covered stirrups or tapaderos.

Prohibited Tack: Mechanical hackamore, draw reins, tie down, running or other type martingales, cavesson noseband, crops, bats, whips.

Attire: Rider shall wear western style long pants, western style long sleeve, collared shirt, a western hat, and western boots. Optional Attire: Chaps, spurs, coats, vest, jackets, gloves

Class Procedures:

The horse will be judged on riding qualities of gaits (walk, running walk and lope), flying change of leads, back, response to the exhibitor, manners and disposition.

The following pattern and routine is prescribed. It is essential that the judge and exhibitor adhere to it.

(a) The small circles represent markers (cones recommended). These should be separated by a uniform distance of not less than 30 feet, or more than 50 feet.

(b) The rectangle represents an obstacle (one small log recommended) just high enough to break the horse's stride.

(c) The long and sometimes twisting line indicates the direction to travel and gaits at which the animal is to move. The dash/dot line (•-•-•) or dot line (•••••) indicates the walk, the dash line (- - -) the flat walk, and the solid line (_____) the lope.

(d) The exhibitor should proceed with the routine as indicated by the pattern.

(e) The judge may require an exhibitor to repeat or reverse any part of the routine.

(f) Only one hand may be used on the reins and must not be changed.

(g) The hand is to be around the reins. One finger between reins is permitted when split reins are used. While the horse is in motion, the exhibitor's hands must be clear of the horse and saddle.

Western Riding Scoring and Penalties

(a) Scoring will be on a basis of 0-100 with 70 denoting an average performance.

(1) Scoring guidelines: points will be added or subtracted from the maneuvers on the following basis, ranging from plus 1.5 to minus 1.5: -1.5 extremely poor, -1 very poor, -.5 poor, 0 average, +.5 good, +1 very good, +1.5 excellent. Maneuver scores are to be determined independently of penalty points.

(b) A contestant shall be penalized each time the following occur:

One-half (1/2) point

- tick or light touch of log
- hind legs skipping or coming together during lead change
- non-simultaneous lead change (Front to hind or hind to front)

One (1) point

- hitting or rolling log
- out of lead more than one stride either side of the center point and between the markers
- splitting the log (log between the two front or two hind feet) at the lope
- break of gait at the flat walk or running walk up to two strides

Three (3) points

- not performing the specific gait (running walk or lope) or not stopping when called for in the pattern, within 10 feet (3 meters) of the designated area
- simple change of leads
- out of lead at or before the marker prior to the designated change area or out of lead at or after the marker after the designated change area
- additional lead changes anywhere in pattern (except when correcting an extra change or incorrect lead)
- in pattern one failure to start the lope within 30 feet (9 meters) after crossing the log at the running walk
- break of gait at running walk or jog for more than two strides
- break of gait at the lope

Five (5) points

- out of lead beyond the next designated change area (note: failures to change, including cross-cantering. Two consecutive failures to change would result in two five point penalties).
- blatant disobedience including kicking out, biting, bucking and rearing

Disqualified - 0 score

- illegal equipment
- willful abuse
- off course
- knocking over markers
- completely missing log
- major refusal - stop and back more than 2 strides or 4 steps with front legs
- major disobedience or schooling
- failure to start lope within 30 feet of designated area.
- overturn of more than 1/4 turn

WESTERN RIDING PATTERN 1

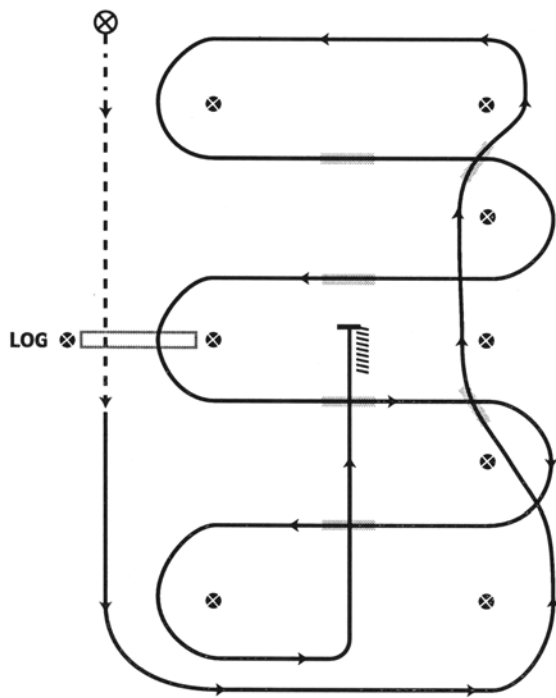

⊗ START CONE WALK - - - - - FLAT WALK - - - - -
 LEAD CHANGING AREA [hatched] LOPE ————

1. Walk at least 15' & Flat walk over log
2. Transition to left lead & lope around end
3. First line change
4. Second line change lope around the end of arena
5. First crossing change
6. Second crossing change
7. Lope over log
8. Third crossing change
9. Fourth crossing change
10. Lope up the center, stop & back

WESTERN RIDING PATTERN 2

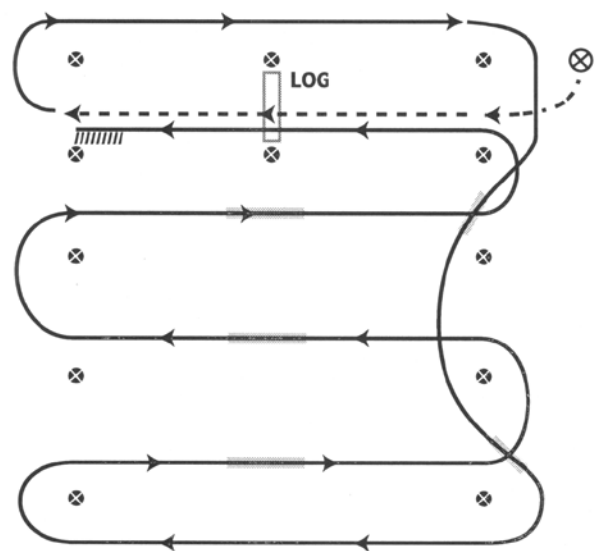

⊗ START CONE WALK - - - - - FLAT WALK - - - - -
 LEAD CHANGING AREA [hatched] LOPE ————

1. Walk, transition to flat walk, flat walk over log
2. Transition to right lead & lope around end
3. First line change
4. Second line change, lope around end of arena
5. First crossing change
6. Second crossing change
10. Third crossing change
11. Lope over log
12. Lope, stop & back

WESTERN RIDING PATTERN 3

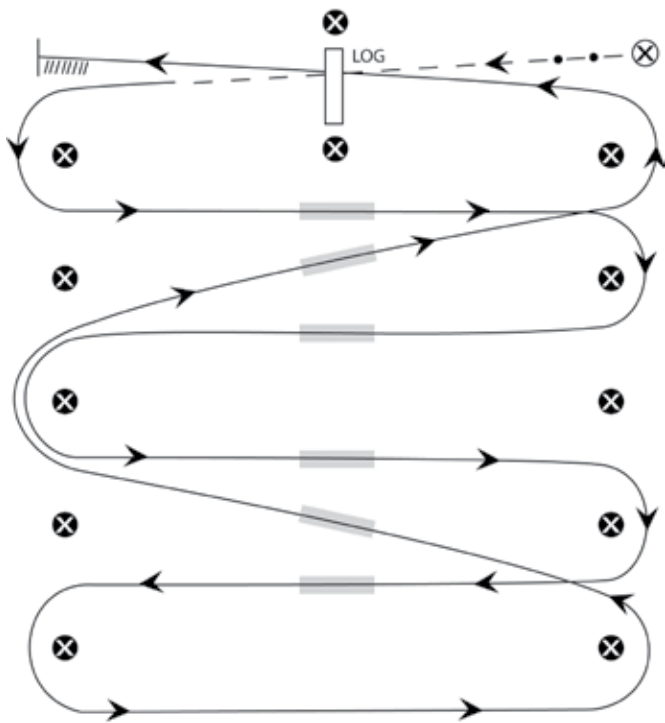

1. Walk, transition to flat walk, flat walk over log
2. Transition to left lead & lope around end
3. First crossing change
4. Second crossing change
5. Third crossing change
6. Fourth crossing change, lope around end of arena
7. Fifth crossing change
8. Sixth crossing change
9. Lope over log
10. Lope, stop & back

WESTERN RIDING PATTERN 4

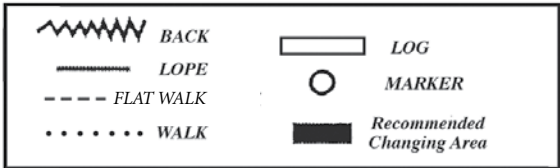
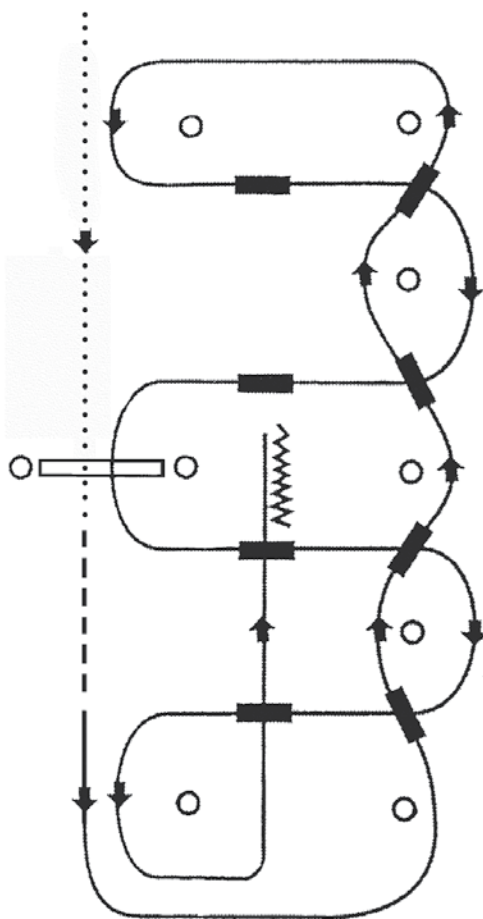

Basic Reining Score Sheet

Class Name: _____ Class Number: _____

Show Name: _____ Date: _____

Scoring

Maneuver Scores	Extremely Poor -1 1/2	Very Poor -1	Poor -1/2	Correct 0	Good +1/2	Very Good +1	Excellent +1 1/2
------------------------	-----------------------	--------------	-----------	-----------	-----------	--------------	------------------

Entry Number	Maneuver Description	1	2	3	4	5	6	7	8	Penalties	Total Score
	Penalty										
	Score										
	Running Total										
	Penalty										
	Score										
	Running Total										
	Penalty										
	Score										
	Running Total										
	Penalty										
	Score										
	Running Total										
	Penalty										
	Score										
	Running Total										
	Penalty										
	Score										
	Running Total										
	Penalty										
	Score										
	Running Total										
	Penalty										
	Score										
	Running Total										

Judge's Signature: _____

Hunter Hack Score Sheet

CREDIT: STYLE OVER FENCES
 EVEN HUNTING PACE
 WAY OF GOING
 FLAT WORK
 MANNERS

PENALTIES: SAME AS TWH Over Fences

JUMP HEIGHTS: 2 FEET 3 INCHES TO 3 FEET

FAULTS:

BEING ON WRONG LEAD EXCESSIVE SPEED EXCESSIVE SLOWNESS BREAKING GAIT FAILURE TO TAKE GAIT WHEN CALLED FOR	HEAD CARRIED TOO HIGH OR TOO LOW NOSING OUT OR FLEXING BEHIND THE VERTICAL OPENING MOUTH EXCESSIVELY STUMBLING
--	--

AWARDS	
1.	11.
2.	12.
3.	13.
4.	14.
5.	15.
6.	16.
7.	17.
8.	18.
9.	19.
10.	20.

DISQUALIFICATION : Head consistently too low or over flexed except in novice classes

W/O	Exhibitor No	Jumps (70%)		Score	Flat Work (30%)	Total Score	Way of Going	Place
		1	2					
1.								
2.								
3.								
4.								
5.								
6.								
7.								
8.								
9.								
10.								
11.								
12.								
13.								
14.								
15.								

TRAIL SCORE SHEET

JUDGE
CLASS
DATE

OBSTACLE SCORES: -1/2 Extremely Poor, -1 Very Poor, -1/2 Poor, 0 Correct, +1/2 Good, +1 Very Good, +1 1/2 Excellent

OBSTACLE DESCRIPTION														
----------------------	--	--	--	--	--	--	--	--	--	--	--	--	--	--

WORKING ORDER	ENTRY NUMBER	OBSTACLE	1	2	3	4	5	6	7	8	9	10	11	12	PENALTY TOTAL	FINAL SCORE
		PENALTY														
		OBSTACLE SCORE														

		PENALTY														
		OBSTACLE SCORE														

		PENALTY														
		OBSTACLE SCORE														

		PENALTY														
		OBSTACLE SCORE														

		PENALTY														
		OBSTACLE SCORE														

		PENALTY														
		OBSTACLE SCORE														

		PENALTY														
		OBSTACLE SCORE														

		PENALTY														
		OBSTACLE SCORE														

		PENALTY														
		OBSTACLE SCORE														

		PENALTY														
		OBSTACLE SCORE														

JUDGES SIGNATURE _____

WESTERN RIDING SCORE SHEET

JUDGE
CLASS
DATE

WORKING ORDER	ENTRY NUMBER	MANEUVER DESCRIPTION	W/J/Log	Trans LL	1L	2L	3L	4L	1X	2X	LOG	3X	4X	STOP/BACK	PENALTY TOTAL	FINAL SCORE
		1	2	3	4	5	6	7	8	9	10	11	12			
		PENALTY														
		MANEUVER SCORE														
		PENALTY														
		MANEUVER SCORE														
		PENALTY														
		MANEUVER SCORE														
		PENALTY														
		MANEUVER SCORE														
		PENALTY														
		MANEUVER SCORE														
		PENALTY														
		MANEUVER SCORE														
		PENALTY														
		MANEUVER SCORE														
		PENALTY														
		MANEUVER SCORE														
		PENALTY														
		MANEUVER SCORE														

JUDGES SIGNATURE

